

M10L



- ▶ Medium vacuum levels to 90 -kPa
- ▶ Small size and low weight
- ▶ Operates at only 0.38 MPa

Supplied with compressed-air hose connector.

TECHNICAL DATA

Description	Unit	Value
Feed pressure, max.	MPa	0.7
Noise level	dBA	57–68
Temperature range	°C	-20–80
Weight	g	30
Material		PA, POM, NBR, SS

VACUUM FLOW

Feed pressure MPa	Air consumption NI/s	Vacuum flow (NI/s) at different vacuum levels (-kPa)											Max vacuum -kPa
		0	10	20	30	40	50	60	70	80	90		
0.60	1.1	1.3	0.91	0.48	0.29	0.26	0.21	0.13	0.090	0.030	–	84	
0.38	0.76	1.1	0.57	0.39	0.35	0.30	0.21	0.12	0.060	0.020	–	81	

EVACUATION TIME

Feed pressure MPa	Air consumption NI/s	Evacuation time (s/l) to reach different vacuum levels (-kPa)										Max vacuum -kPa
		10	20	30	40	50	60	70	80	90		
0.60	1.1	0.079	0.20	0.50	0.92	1.4	2.1	3.0	5.0	–	84	
0.38	0.76	0.13	0.31	0.57	0.90	1.3	2.0	3.2	7.1	–	81	

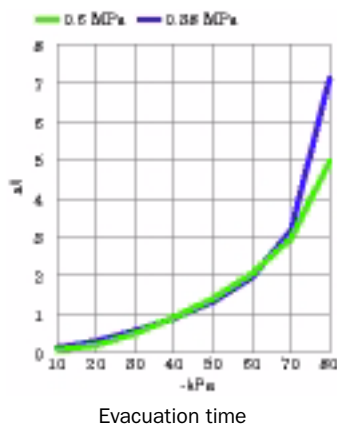
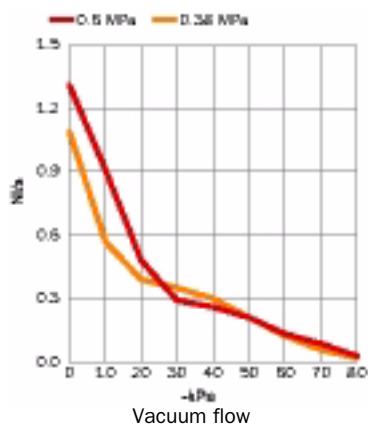

ORDERING INFORMATION

Description	Art. No.
Vacuum pump MINI M10L, conn. A, NBR sealings	0102871
Vacuum pump MINI M10L, conn. A, NBR sealings, non-return valve	0102872

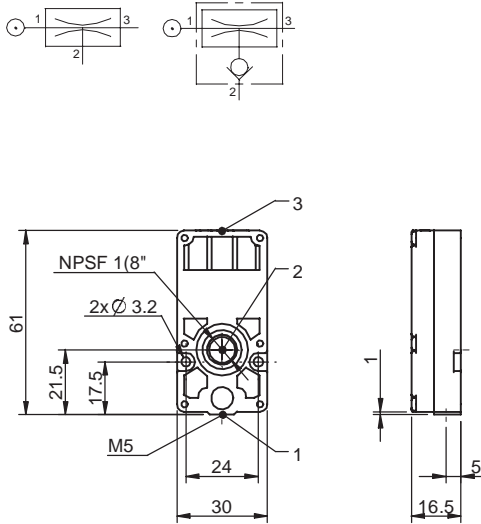

ORDERING INFORMATION, ACCESSORIES

Description	Art. No.
Sealing kit MINI 5-28, NBR	3201097
Sealing kit MINI 5-28, Viton®	3201097V
Sealing kit MINI 5-28, EPDM	3201097E

Sealing kits include flap valves, gaskets and compressed-air filters.

Vacuum pumps
MINI