

**Industri / Industry**

L-dørgreb / L-handles . . . . .	3
T-dørgreb / T-handles . . . . .	12
Indbygningshåndtag og -låse / Deep-dish paddles . . . . .	15
Stanglåse / Rod latches . . . . .	22
Truck- og kabinetlåse / Truck and cabinet locks . . . . .	27
Kasselåse / Slam locks . . . . .	34
Kabinet- og handskerumslåse / Compartment locks . . . . .	37
System- og nybygningsnøgler / Mandrel keys . . . . .	42
Kilelåse og fjederigler / Antiluce fasteners and spring bolts . . . . .	45
Snaplåse og modhold / Fasteners and catch plates . . . . .	47
Snap- og hagelåse / Claw latches and budget latches . . . . .	61
Lakajkrammer og dørstropper / Door retainer cramps and door retainer straps . . . . .	65
Dør- og hjelmholder / Door retainers and fasteners . . . . .	68
Håndtag og bøjlegreb / Handles and door handles . . . . .	79
Hængsler / Hinges . . . . .	84

**Opbygning / Trailer parts**

Stanglåse og indbygningslukker / Rod latches and paddle locks . . . . .	101
Værktøjskasser / Toolboxes . . . . .	121
Skærme og skærmholdere / Mudguards and stays . . . . .	126
Stænklapper / Mudflaps . . . . .	133
Stiger, konsoller og lygtebomme / Ladders, Brackets and Bumpers . . . . .	134
Surringsskinner og gjorde / Load bonding tracks and girths . . . . .	136
Surringsdele / Lashing parts . . . . .	140
Gummistropper / Rubber straps . . . . .	142
Dæmpere og buffere / Dampers and buffers . . . . .	147
Læssebagsmæksprofiler og Alu. lister / Special profiles for tailboard and alu. profiles . . . . .	152
Poliall og Centraflex / Poliall and Centraflex . . . . .	158
Gasfjedre / Gas springs . . . . .	159
Nødhamre / Emergency hammers . . . . .	162
Tagluger og skydevinduer / Roof hatches and sliding windows . . . . .	164
Trailerspil / Winches . . . . .	166
Navkapsler / Hub caps . . . . .	170
Lamper / Lamps . . . . .	174
De Gule Sider / Yellow pages . . . . .	176
Tecna balancer . . . . .	183

**Velkommen** til Sindby's beslagkatalog. Det indeholder en komplet vifte af nøje udvalgte kvalitetsprodukter, både til ny- og eftermontering.

Alle produktmål er angivet i millimeter. De øvrige data er angivet efter anvisning fra vore leverandører.

Eventuelle spørgsmål til kvalitet og mål m.v. besvares af en af vore specialister, som naturligvis altid vil stå til jeres disposition, hvis I henvender jer til os.

Vi betragter os selv som problemløsere, og vores primære opgave er netop at finde løsninger på de opgaver vore kunder stiller os. Vore sælgere har hver deres geografiske område, hvor den nødvendige kontakt med kunderne vedligeholdes, og de er samtidig specialister inden for hver deres produktområde. På den måde kan vores administration i Vejle dirigere den rette person derhen, hvor der er brug for specialviden.

Vore indkøbere er på messer i hele verden for altid at være på forkant med udviklingen. På den måde er der gennem mange år opbygget et stort netværk af forbindelser til producenter, og det lykkes næsten altid at skaffe de produkter vore kunder ønsker.

Inden en ny vare kommer i vort sortiment, er der aflagt besøg på fabrikken. Vi vil sikre os, at der er tale om en kvalitetsvare, og at leveringssikkerheden lever op til vore forventninger.

Vi har tusindvis af varer på vort lager i Vejle og sender dagligt alt lige fra små pakker til hele vognlæs ud til vore mange kunder rundt i Danmark.

Vi står til jeres disposition mandag til fredag og er ikke længere væk end en mail eller en telefonopringning.

**Med venlig hilsen**  
Keld Larsen



**Welcome** to Sindby's catalogue for handles, hinges and trailerparts. Our catalogue includes a complete range of carefully selected quality products, both for new installation and renewal of existing products.

All product dimensions are stated in millimetres. The other data stated is according to suppliers' specifications.

If you have questions, please call us and one of our specialists will always be at your disposal with information about quality, measures etc.

We consider ourselves to be problem solvers and our primary task is to find solutions to the tasks given to us by our customers. Our salesmen all attend to their own geographic district in order to maintain the necessary contact to the customers, and at the same time, they are specialists within their own product area. Thus, our administration in Vejle can direct the right person to where his special knowledge is required.

Our purchasers attend exhibitions worldwide in order to keep abreast of developments. In this way we have over the years built up a large network of connections to producers, and nearly always do we succeed in getting hold of the products which our customers desire.

Before a new article is included in our assortment we have visited the producer's factory. We want to make sure that we buy only high-class articles and that our expectations to delivery are fulfilled.

We keep thousands of different products in store in Vejle and every day we send anything from small parcels up to whole loads to our many customers in Denmark.

We are at your disposal from Monday till Friday and are only an e-mail or a phone call away.

**Kind regards**  
Keld Larsen



10.103

L-dørgreb med flange uden lås  
Alloy/krom

Fluted handle, non-locking  
Alloy/chrome



A: 112 mm  
B: 8 x 120 mm  
C: 36 mm  
Mount: Ø 16 mm

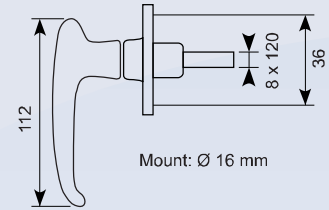

10.203

L-dørgreb med flange uden lås  
Alloy/krom

Fluted handle, non-locking  
Alloy/chrome



A: 112 mm  
B: 8 x 112 mm  
C: 44 mm  
Mount: Ø 16 mm

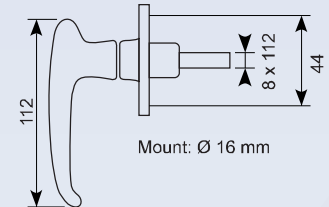

10.104J

Dørgreb med lås

L-door handle with flange locking



A: 113 mm  
C: 45 mm  
Stift: 8 x 107 mm

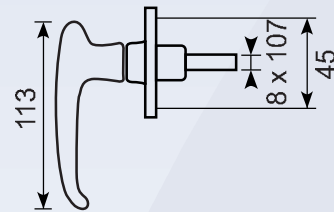

L-Dørgreb

L-dørgreb med flange og lås  
Alloy/krom, med 2 nøgler.

Fluted handle, locking  
Alloy/chrome, with two keys



Vare nr.	A	B	C	Mount	Nøgle/Key
	mm	mm	mm	mm	
10.104	112	8 x 120	36	Ø21	
10.104S	112	8 x 120	36	Ø21	FS880
10.204	112	8 x 120	44	Ø21	
10.204S	112	8 x 120	44	Ø21	FS880
10.204A	112	8 x 120	44	Ø21	FS880
10.204X	112	8 x 120	44	Ø21	FS900

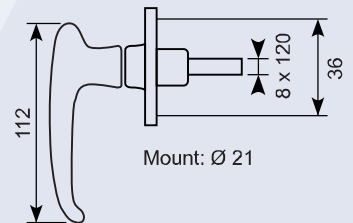

L-Dørgreb

L-dørgreb med flange og lås  
Alloy/krom og 2 nøgler.

Arched handle with flange,  
locking  
Alloy/chrome and two keys.



Vare nr.	A	B	C	Mount	Nøgle/Key
	mm	mm	mm	mm	
10.106	112	8 x 120	36	Ø21	
10.106S	112	8 x 120	36	Ø21	FS880
10.206	112	8 x 120	44	Ø21	
10.206S	112	8 x 120	44	Ø21	FS880

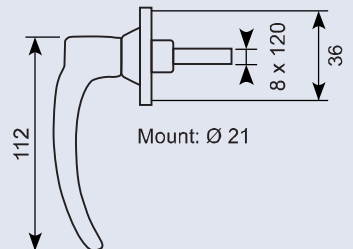

● Godt køb / best buy

**10.206**

**L-dørgreb med flange og lås**  
**Alloy/krom og 2 nøgler.**

Arched handle with flange, locking  
 Alloy/chrome, two keys

A: 130 mm  
 B: 8 x 120 mm  
 C: 44 mm  
 Mount: Ø21 mm

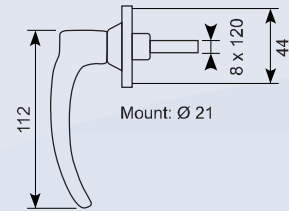
**10.206S**

**L-dørgreb med flange og lås**  
**Alloy/krom og 2 nøgler. FS880**

Arched handle with flange, locking  
 Alloy/chrome and two keys FS880

A: 130 mm  
 B: 8 x 120 mm  
 C: 44 mm  
 Mount: Ø21 mm

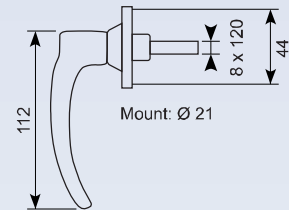
**10.105**

**L-dørgreb med flange uden lås**  
**Alloy/krom**

Arched handle with flange, non-locking  
 Alloy/chrome

A: 130 mm  
 B: 8 x 120 mm  
 C: 36 mm  
 Mount: Ø 16 mm

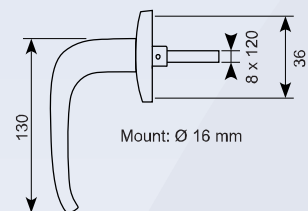
**10.205**

**L-dørgreb med flange uden lås**  
**Alloy/ krom**

Arched handle, non-locking  
 Alloy/chrome.

A: 130 mm  
 B: 8 x 120 mm  
 C: 44 mm  
 Mount: Ø 16 mm

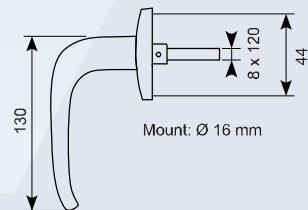
**10.133**

**L-dørgreb med flange uden lås**  
**Alloy/krom**  
**Monteres med skruer fra bagsiden**

Lever L-handle, non-locking  
 Alloy/chrome, concealed fixing

A: 115 mm  
 B: 8 x 125 mm  
 C: 38 mm  
 Mount: Ø14 mm

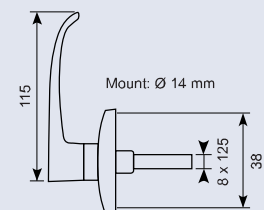
**10.134**

**L-dørgreb med flange og lås**  
**Alloy/krom med 2 nøgler**

Lever L-handle, locking  
 Alloy/chrome with two keys, open fixing

A: 115 mm  
 B: 8 x 125 mm  
 C: 38 mm  
 Mount: Ø14 mm

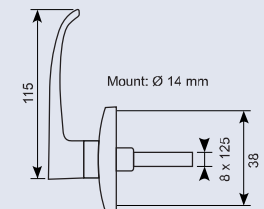
**10.135**

**L-dørgreb med flange og uden lås**  
**Alloy/krom**

Lever L-handle with flange, non-locking,  
 open fixing - Alloy/chrome

A: 115 mm  
 B: 8 x 135 mm  
 C: 38 mm  
 Mount: Ø14 mm

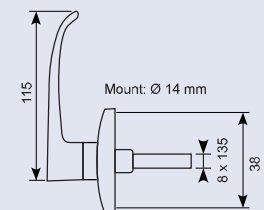



**10.224**

**L-dørgreb med flange og lås**  
**Alloy/krom og 2 nøgler.**

Handle, heavy-duty model, locking  
 Alloy/chrome and two keys

A: 160 mm  
 B: 8 x 140 mm  
 C: 44 mm  
 Mount: Ø 28 mm

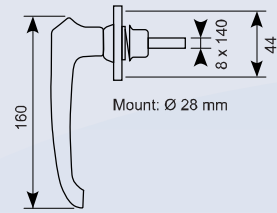

**10.451**

**L-dørgreb med flange uden lås**  
**Alloy/krom**

Handle with flange, non-locking  
 Alloy/chrome

A: 105 mm  
 B: 8 x 125 mm  
 C: 44 mm  
 Mount: Ø 16 mm

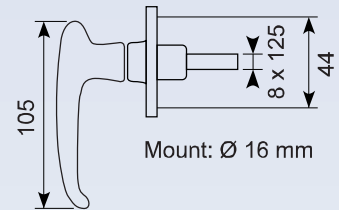

**10.491**

**L-dørgreb med flange uden lås**  
**Alloy/krom**  
**OBS. Plan anlægsflade**

Plant-on L-Handle with flange, non-locking  
 Alloy/chrome

A: 115 mm  
 B: 8 x 125 mm  
 C: 38 mm  
 Mount: Ø 11 mm

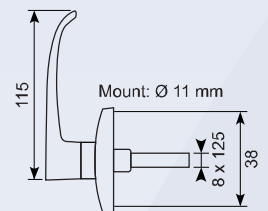

**10.503**

**L-dørgreb med flange og lås**  
**Alloy/krom og 2 nøgler.**  
**OBS. Frakobler håndtaget**

L-Handle with flange, locking  
 Alloy/chrome, with two keys  
 OBS: Disconnects handle

A: 135 mm  
 B: 8 x 115 mm  
 C: 44 mm  
 Mount: Ø 18 mm

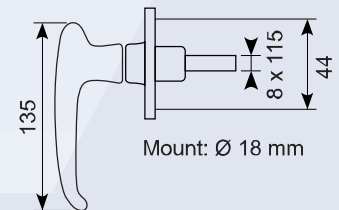

**10.120**

**L-dørgreb til indboring**  
**Alloy/krom, uden lås.**

Exterior handle, non-locking  
 Alloy/chrome  
 Handle: 95 mm  
 Shaft: 8 x 120 mm  
 Shoulder dia. : 16 x 9 mm

Håndtag: 95 mm  
 Stift: 8 x 120 mm  
 Brystmål dia.:  
 16 mm x 9 mm



**10.501**

**L-dørgreb til indboring**  
**Alloy/krom, uden lås**

Handle, non-locking, recess, with open fixing  
 Alloy/chrome

A: 108 mm  
 B: 8 x 120 mm  
 C: 19 mm  
 D: 7 mm

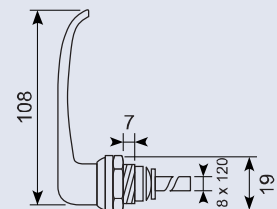

**10.502**

**L-dørgreb til indboring**  
**Alloy/krom, med lås**

Handle, locking, recess, with open fixing  
 Alloy/chrome

A: 115 mm  
 B: 8 x 135 mm  
 C: 19 mm  
 D: 7 mm

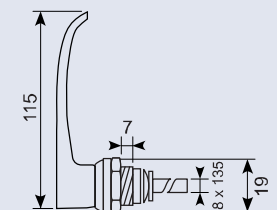

**10.502S**

**L-dørgreb til indboring**  
**Alloy/krom, med lås FS880**

Handle, locking, recess, with open fixing  
 Alloy/chrome. FS880

A: 115 mm  
 B: 8 x 135 mm  
 C: 19 mm  
 D: 7 mm

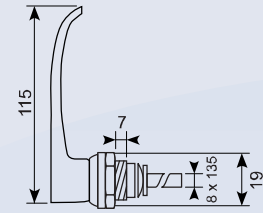
**10.504**

**L-dørgreb til indboring**  
**Alloy/krom, med lås. Nøgle FS880**  
**Passer til skål nr. 10.511 og 10.512**

L-Handle, locking, recess  
 Alloy/chrome, with two keys FS880  
 Fits recess pan 10.511 and 10.512

A: 115 mm  
 B: 8 x 100 mm  
 C: 24 mm  
 D 5 mm

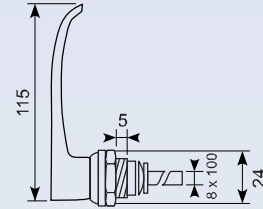
**10.511**

**Indbygningsskål til håndtag**  
**Passer til håndtag 10.504**  
**Ubehandlet stål.**  
**Venstre - som foto**

Recess pan for handle  
 Raw, unpierced  
 Fits handle 10.504  
 LH - like photo

A: 155 mm  
 B: 167 mm

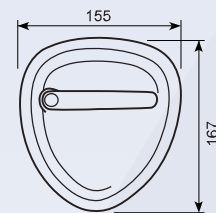
**10.512**

**Indbygningsskål til håndtag**  
**Passer til håndtag 10.504**  
**Ubehandlet stål.**  
**Højre med hul**

Recess pan for handle  
 Raw, unpierced  
 Fits handle 10.504  
 RH - with hole

A: 155 mm  
 B: 167 mm

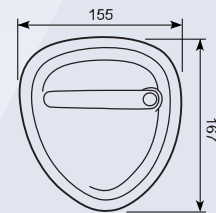
**10.513**

**Indbygningsskål til håndtag**  
**Passer til håndtag 10.504**  
**Ubehandlet stål.**  
**Venstre uden hul**

Recess pan for handle  
 Raw, unpierced  
 Fits handle 10.504  
 LH - no hole

A: 155 mm  
 B: 167 mm

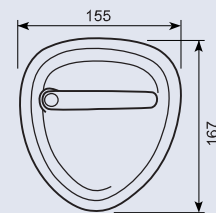
**10.514**

**Indbygningsskål til håndtag**  
**Passer til håndtag 10.504**  
**Ubehandlet stål.**  
**Højre uden hul**

Recess pan for handle  
 Raw, unpierced  
 Fits handle 10.504  
 RH - no hole

A: 155 mm  
 B: 167 mm

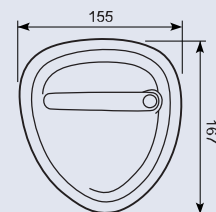

### 10.537R



L-dørgreb til indboring.  
Rustfrit stål uden lås.  
O-ring mellem håndtag og gennemføring.  
Passer til STUV, EMKA, PALER.

Stainless L-Handle, non-locking  
with escutcheon and 8 mm shaft  
Fits STUV, EMKA, PALER.

A: 120 mm  
B: 8 med M6 bolt  
C: 22 mm  
D: 10 mm  
Rotation: 180°

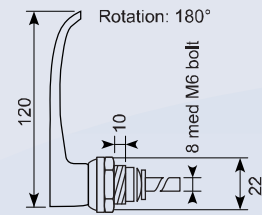

### 10.537RA



L-dørgreb til indboring.  
Rustfrit stål uden skaft.

Stainless L-Handle, without shaft  
with escutcheon and latch bar

A: 112 mm  
B: 8 med M6 bolt  
C: 22 mm  
D: 10 mm

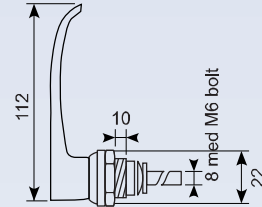

### 17.147



Indvendig håndtag - 110 mm  
Forkromet alloy.  
Til 8 mm dorn, med bryst til roset.

Inside handle - 110 mm  
Chrome-plated alloy  
For 8 mm pin

### 17.152



Indvendig håndtag - 112 mm  
Forkromet alloy.  
Til 8 mm dorn, med møtrik.

Inside Lock Handle - 115 mm  
Chrome-plated alloy  
Through-going hole for 8 mm pin

### 17.303



Roset to-delt med fjeder  
Forkromet, passer til 17.147

Spring escutcheon  
Chrome-plated, fits 17.147

### 10.300



L-håndtag, flangemonteret med lås, 180°  
incl. 2 stk. nøgler

Titan heavy-duty handle, locking, 180°  
Incl. 2 keys.

A: 185 mm  
B: 8 x 130 mm  
C: 44 mm  
Mount: Ø27 mm

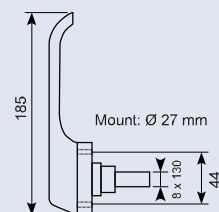

**10.4960**

**L-håndtag, flangemonteret med lås- højre** A: 185 mm  
 Sort pulverlakeret alloy med skjulte skruer  
 Firkantet taste, forberedt til trækstang  
 Håndtag med 10° vanding. Incl. 2 stk. nøgler

Remote control rotary lock assembly - RH  
 Black powder-coated alloy with concealed screws  
 Handle with 10° travel. 2 keys included.

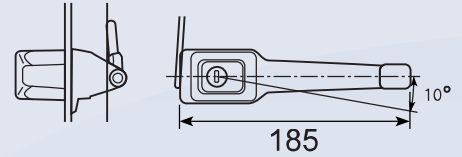
**10.4965**

**L-håndtag, flangemonteret med lås - venstre** A: 185 mm

Remote control rotary lock assembly - LH

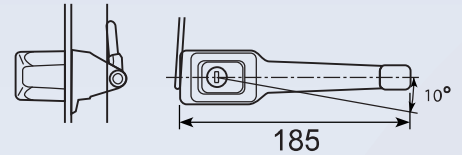
**10.594**

**L-håndtag, flangemonteret uden lås - venstre 90°**  
 Sort pulverlakeret alloy med skjulte skruer.

L-handle, non-locking - LH 90°  
 Black, screws fully concealed

A: 160 mm  
 B: 8 x 50 mm  
 C: 44 mm  
 Mount: Ø 27 mm

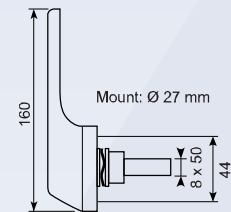
**10.596**

**L-håndtag, flangemonteret uden lås - højre 90°**  
 Sort pulverlakeret alloy med skjulte skruer.

L-handle, non-locking RH 90°  
 Black, screws fully concealed

A: 185 mm  
 B: 8 x 130 mm  
 C: 44 mm  
 Mount: Ø 27 mm

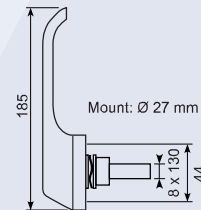
**10.597**

**L-håndtag, flangemonteret uden lås - venstre 90°**

Titan heavy-duty handle, non-locking, 90° - LH

A: 185 mm  
 B: 8 x 130 mm  
 C: 44 mm  
 Mount: Ø 27 mm

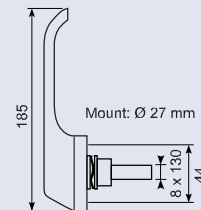
**10.598**

**L-håndtag, flangemonteret med lås - højre 90°**

Titan heavy-duty handle, locking, 90° - RH

A: 185 mm  
 B: 8 x 130 mm  
 C: 44 mm  
 Mount: Ø 27 mm

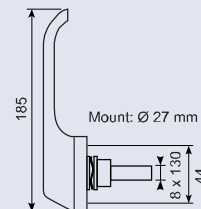

## 10.599



L-håndtag, flangemonteret med lås  
- venstre. 90°.  
Incl. 2 stk. nøgler  
Sort pulverlakeret alloy med skjulte  
skruer.

Titan heavy-duty handle, locking, 90°  
- LH  
Black, screws fully concealed. Incl. 2 keys.

A: 185 mm  
B: 8 x 130 mm  
C: 44 mm  
Mount: Ø27 mm

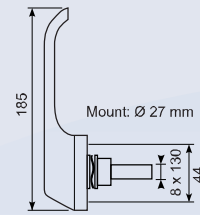

## 10.600



Trykknopgreb med åbne/lukke og lås incl.  
2 stk. nøgler. Sort kunststof med 18 mm  
taster.  
Kan højre- og venstremonteres.  
Monteret med 3 stk. M6 skruer fra  
bagsiden.  
Passer til dørlås 15.501

Pushbutton handle with key cylinder  
Incl. 2 keys  
Black synthetic material  
Fixed with 3 x M6 screws from the back  
Fits cabdoor latch 15.501.

A: 180 mm  
B: 120 mm  
C: 38 mm  
D: 34 mm  
E: 36 mm

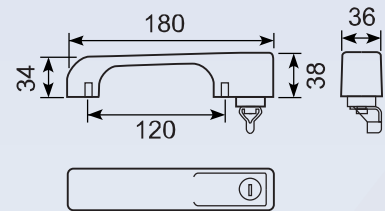

## 10.600A



Trykknopgreb med åbne/lukke og lås incl.  
2 stk. nøgler.  
Sort kunststof med 23 mm taster/  
trykknop.  
Kan højre- og venstremonteres.  
Monteret med 3 stk. M6 skruer fra  
bagsiden.  
Passer til dørlås 15.501

Pushbutton handle with key cylinder  
Incl. 2 keys  
Black synthetic material  
Fixed with 3 x M6 screws from the back  
Fits cabdoor latch 15.501.

A: 180 mm  
B: 120 mm  
C: 38 mm  
D: 34 mm  
E: 36 mm

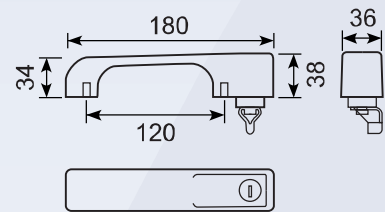

## 10.600C

Løs låsecylinder til 10.600 og 10.600A  
Incl. 2 nøgler



Loose locking cylinder for 10.600 and  
10.600A

## 10.600N

Nøgle til 10.600 og 10.600A  
Nøgle kode 1012



Key for 10.600 and 10.600A  
Key code 1012

## 10.600NX

Nøgle til 10.600 og 10.600A  
Nøgle kode 1001



Key for 10.600 and 10.600A  
Key code 1001

## 10.600S



Trykknopgreb med åbne/lukke og lås  
incl. 2 stk. nøgler.  
Sort kunststof med 18 mm taster.  
Kan højre- og venstremonteres.  
Monteret med 3 stk. M6 skruer fra  
bagsiden.  
Passer til dørlås 15.501  
Med nøgle K1012

Pushbutton handle with key cylinder  
Incl. 2 keys  
Black synthetic material  
Fixed with 3 x M6 screws from the back  
Fits cabdoor latch 15.501.  
With key K1012

A: 180 mm  
B: 120 mm  
C: 38 mm  
D: 34 mm  
E: 36 mm

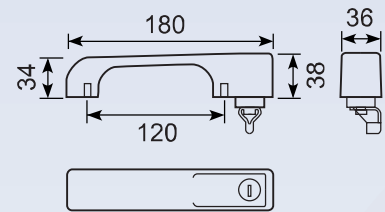

## 10.629

Trykknopgreb med åbne/lukke  
- uden lås

Pushbutton Handle without key cylinder

A: 42 mm  
B: 132 mm  
C: 30 mm  
D: 21 mm

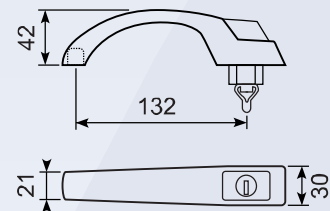

## 10.630

Trykknopgreb med åbne/lukke og  
lås incl. 2 stk. nøgler.  
Sort kunststof med 18 mm taster.  
Kan højre- og venstremonteres.  
Godstykkelse 3 mm.  
Monteres i spec. hul med 1 stk. M6 bolt  
fra bagsiden.

Pushbutton Handle with key cylinder, incl. 2  
keys  
Black synthetic material  
May be fixed to the left or to the right  
Thickness: 3 mm  
Fixed in special hole with 1 M6 bolt from the  
back

A: 42 mm  
B: 132 mm  
C: 30 mm  
D: 21 mm

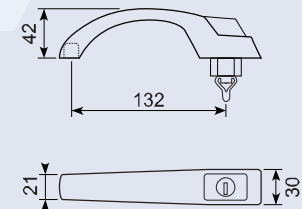

## 10.630S

Trykknopgreb med åbne/lukke og lås  
2 stk. nøgler incl.  
Sort kunststof med 18 mm taster.  
Kan højre- og venstremonteres.  
Godstykkelse 3 mm.  
Monteres i spec. hul med 1 stk. M6 bolt  
fra bagsiden.  
Med nøgle 7725

Pushbutton handle with key cylinder, incl. 2  
keys  
Black synthetic material  
May be fixed to the left or to the right  
Thickness: 3 mm  
Fixed in special hole with 1 M6 bolt from the  
back  
With key 7725

A: 42 mm  
B: 132 mm  
C: 30 mm  
D: 21 mm

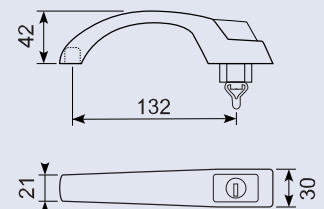

## 10.640



Trykknappgreb med åbne/lukke og lås incl. 2 stk. nøgler.  
Sort kunststof med 18 mm taster.  
Kan højre- og venstremonteres.  
Godstykkelse 15 mm.  
Mont. i Ø 28 mm hul med møtrik fra bagsiden.

A: 186 mm  
B: 136 mm  
C: 27 mm  
D: 25,5 mm  
E: 28 mm

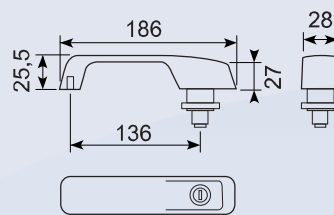

Pushbutton Handle with key cylinder, incl. 2 keys  
Black synthetic material  
May be fixed to the left or to the right  
Thickness: 15 mm  
Fixed in Ø 28 mm hole with M6 bolt from the back

## 10.799A

Gummiunderlag ved fløj til 10.640

Rubber gasket, small, for 10.640

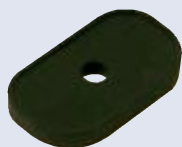

## 10.799B

Gummiunderlag ved cylinder til 10.640

Rubber gasket by cylinder for 10.640

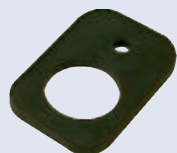

10.523



**T-greb til indboring u. lås**  
**Alloy/krom. Kan monteres i skål.**  
 Large T-handle, non-locking  
 Alloy/chrome, with Easy-Fix mounting

A: 100 mm  
 B: 22 x 24 mm  
 C: 8 x 50 mm  
 D: 8 mm  
 Rotation: 180°

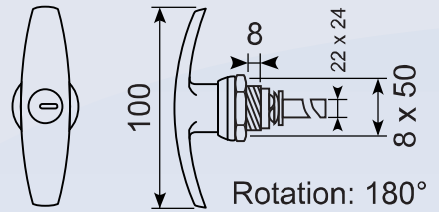

10.52425



**T-greb med lås i skål**  
**Alloy/krom i sortlakeret skål**  
**Med 2 nøgler FS880**  
 T-handle in pan, locking  
 Alloy/chrome, black pan  
 With 2 keys FS880

A: 125 mm  
 B: 105 mm  
 C: 8 x 145 mm  
 D: 155 mm  
 Rotation: 180°

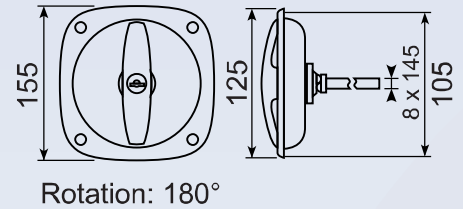

10.535



**T-greb med lås i skål**  
**Alloy/krom i rustfri skål**  
**Med 2 nøgler FS880**  
 T-handle in pan, locking  
 Alloy/chrome, stainless pan  
 With 2 keys FS880

A: 125 mm  
 B: 105 mm  
 C: 8 x 145 mm  
 D: 155 mm  
 Rotation: 180°

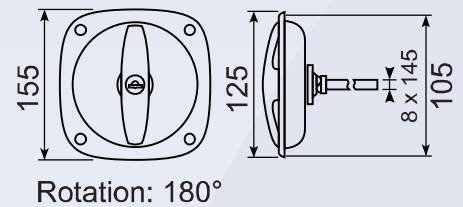

10.536R



**T-greb til indboring u. lås**  
**Rustfrit stål**  
**Passer til STUV-og EMKA paller**  
 T-handle, non-locking  
 Stainless steel  
 Fits STUV and EMKA

A: 80 mm  
 B: 8 x M6 bolt  
 C: 22 x 24 mm  
 D: 10 mm  
 Rotation: 360°

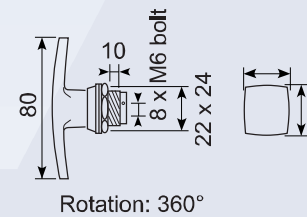

11.105



**T-greb med flange u. lås**  
**Alloy/krom**  
 T-handle with flange, non-locking  
 Alloy/chrome

A: 95 mm  
 B: 8 x 120 mm  
 C: 38 mm  
 Mount: Ø 21 mm

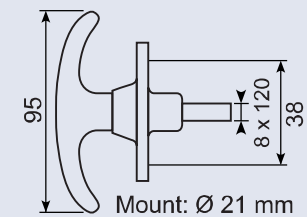

11.205



**T-greb med flange u. lås**  
**Alloy/krom**  
 T-handle with flange, non-locking  
 Alloy/chrome

A: 105 mm  
 B: 8 x 125 mm  
 C: 44 mm  
 Mount: Ø 21 mm

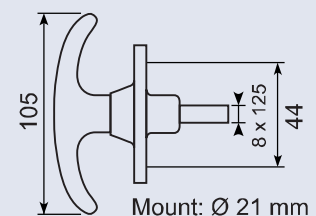

11.106J



**T-dørgreb**  
 T-door handle with flange, locking, alloy/  
 chrome, with two keys

A: 100 mm  
 B: 8 x 107 mm  
 C: 45 mm

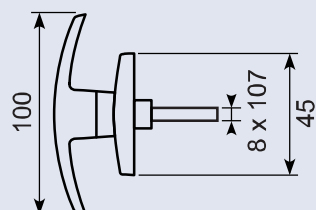

● Godt køb / best buy



## T-Dørgreb

T-greb med flange og lås  
Alloy/krom, med 2 nøgler

T-handle with flange, locking  
Alloy/chrome, with 2 keys



Vare nr.	A	B	C	Mount	Nøgle/Key
	mm	mm	mm	mm	
11.106	95	8 x 120	38	Ø21	
11.106S	95	8 x 120	38	Ø21	FS880
11.206	105	8 x 125	44	Ø21	
11.206X	105	8 x 125	44	Ø21	FS932

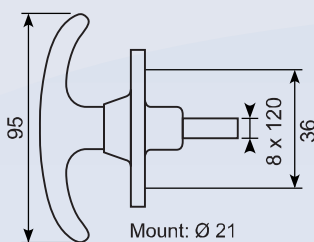

### 11.132

T-greb med flange og lås  
Alloy/krom, incl. 2 nøgler

T-handle with flange, locking  
Alloy/chrome, incl. 2 keys



A: 100 mm  
B: 8 x 125 mm  
C: 38 mm  
Mount: Ø 14 mm  
Rotation: 180°

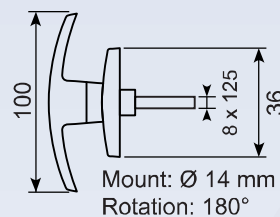

### 11.134

T-greb med flange og lås  
Alloy/krom, incl. 2 nøgler. Skjult montage

T-handle with flange, locking  
Alloy/chrome, incl. 2 keys. Concealed fixing



A: 100 mm  
B: 8 x 115 mm  
C: 51 mm  
Mount: Ø 21 mm  
Rotation: 90°

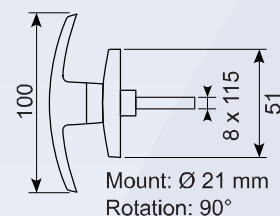

### 11.202

T-greb med flange og lås  
Alloy/krom, incl. 2 nøgler. Skjult montage

T-handle with flange, locking  
Alloy/chrome, incl. 2 keys. Concealed fixing



A: 65 mm  
B: 8 x 125 mm  
C: 38 mm  
Mount: Ø 14 mm

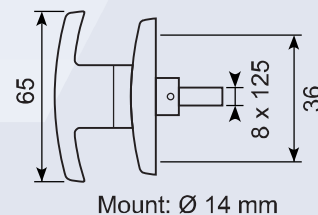

### 11.202S

T-greb med flange og lås  
Alloy/krom, incl. 2 nøgler. FS880. Skjult montage

Handle with flange, locking  
Alloy/chrome, incl. 2 keys. FS880. Concealed fixing



A: 65 mm  
B: 8 x 125 mm  
C: 38 mm  
Mount: Ø 14 mm

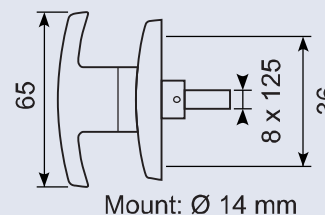

### 11.203

T-greb med flange og lås  
Alloy/krom, incl. 2 nøgler

T-handle with flange, locking  
Alloy/chrome, incl. 2 keys



A: 65 mm  
B: 8 x 125 mm  
C: 38 mm  
Mount: Ø 14 mm

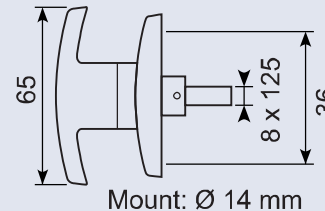

### 11.224

T-greb med flange og lås  
Alloy/krom, incl. 2 nøgler.

T-handle with flange, locking  
Alloy/chrome, incl. 2 keys.



A: 135 mm  
B: 8 x 120 mm  
C: 44 mm  
Mount: Ø 21 mm  
Rotation: 360°

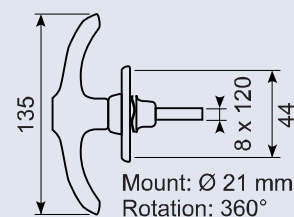

### 11.224S



**T-greb med flange og lås**  
**Alloy/krom, incl. 2 nøgler. FS880**

T-handle with flange, locking  
Alloy/chrome, incl. 2 keys FS880

A: 135 mm  
B: 8 x 120 mm  
C: 44 mm  
Mount: Ø21 mm  
Rotation: 360°

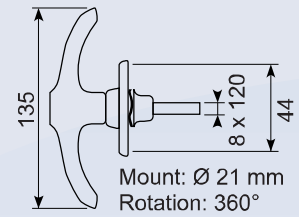

### 11.225



**T-greb med trekantflange og lås**  
**Alloy/krom, incl. 2 nøgler. "Morris Minor".**  
**Skjult montage**

T-handle with heartshaped flange, locking  
Alloy/chrome, incl. 2 keys. "Morris Minor".  
Concealed fixing

A: 140 mm  
B: 8 x 50 mm  
Mount: Ø 21 mm  
Rotation: 360°

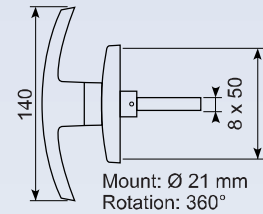

### 11.230



**T-greb til indboring u. lås**  
**Alloy sortlakeret med justerbar tunge.**  
**Passer til STUV og EMKA paler**

Small T-handle, non-locking  
black, with Easy-Fix mounting  
Fits STUV and EMKA

A: 80 mm  
B: 8 x M6 bolt  
C: 22 x 24 mm  
D: 10 mm  
Rotation: 360°

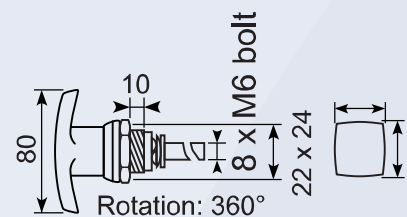

### 11.233



**T-vrider med flange og lås**  
**Alloy/sortlakeret, incl. 2 nøgler.**

"Lowline T" with flange, locking  
Alloy/black, incl. 2 keys.

A: 97 mm  
B: 8 x 60 mm  
C: 40 mm  
Mount: Ø23 mm  
Rotation: 90°

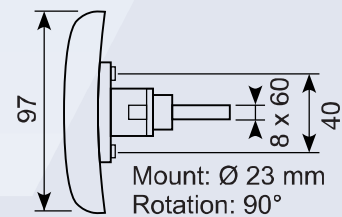

### 11.240



**T-dørgreb mini**  
**Alloy/krom med lås.**  
**Leveres incl. 2 nøgler**

Turnbutton lock  
Alloy/chrome, locking.  
Incl. 2 keys.

A: 45 mm  
B: 22 x 24 mm  
C: 37 mm  
Rotation: 180°

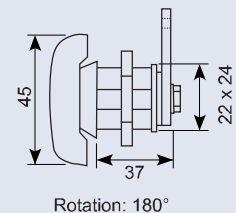

### 16.373S



**T-dørgreb med dobbelt pal**  
**Sort kunststof**

T-Handle, screw-fix  
Black synthetic material

A: 65 mm  
B: 8 x 125 mm  
C: 22 x 24 mm  
Mount: Ø14 mm  
Rotation: 180°

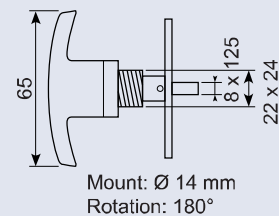

### 18.0267080



**T-skabslås til tunge**  
**Alloy/krom**

Fixed-key lock  
Alloy/chrome

Montagehul: Ø 22 mm  
Håndtag: 78 mm

## Indbygningshåndtag og -låse / Deep-dish paddles

50.9576



**Alu. drejelås  
8 mm FK, eloxeret**

90 x 90 mm

Aluminium turnlock, anodized, 8 mm square

15.525

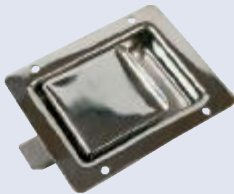

**Indbygningshåndtag uden lås  
Rustfri stål**

Paddle handle, non-locking  
Stainless steel

A: 120 mm  
B: 97 mm  
C: 76 mm  
D: 95 mm  
E: 84 mm  
F: 70 mm  
G: 19 mm  
H: 33 mm  
I: 22 mm  
J: 25 mm

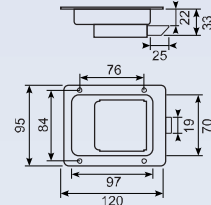

15.526

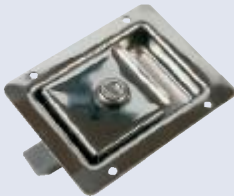

**Indbygningshåndtag med lås  
Incl. nøgler CH545**

Paddle handle, locking  
Incl. keys CH545

A: 120 mm  
B: 97 mm  
C: 76 mm  
D: 95 mm  
E: 84 mm  
F: 70 mm  
G: 19 mm  
H: 33 mm  
I: 22 mm  
J: 25 mm

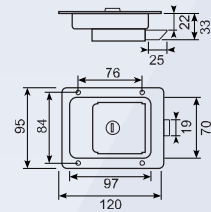

15.529

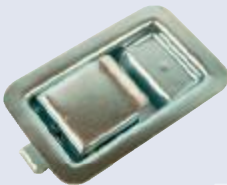

**Dørlås til indbygning med vippehåndtag  
El-galvaniseret jern, uden lås og knop.  
Leveres med sort kunststofunderlag.**

Small paddle lock  
Zinc-plated, non-locking, no knob.  
Supplied with black, moulded gasket.

A: 140 mm  
B: 88 mm  
C: 22 mm  
D: 78 mm

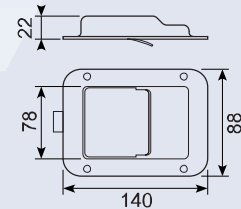

15.529S



**Dørlås til indbygning med vippehåndtag  
Rustfri stål, uden lås og knop.**

Mid-size flush lock  
Stainless steel, non-locking, no knob.

A: 140 mm  
B: 108 mm  
C: 22 mm  
D: 78 mm

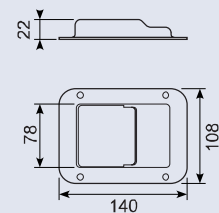

15.529SW

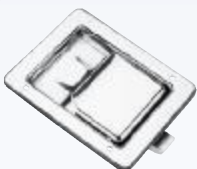

**Indbygningshåndtag uden lås  
Rustfri stål**

Paddle handle, non-locking  
Stainless steel

A: 120 mm  
B: 97 mm  
C: 76 mm  
D: 95 mm  
E: 84 mm  
F: 70 mm  
G: 19 mm

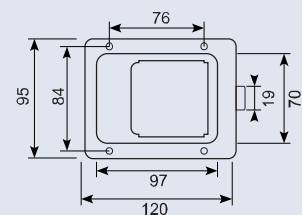

Godt køb / best buy

### 15.530



**Dørlås til indbygning med vippehåndtag**  
**El-galvaniseret jern, med lås uden knop.**  
**Leveres med sort kunststofunderlag og**  
**2 nøgler.**

Small paddle lock  
Zincplated, locking, no knob.  
Supplied with black, moulded gasket and  
2 keys.

A: 140 mm  
B: 89 mm  
C: 22 mm

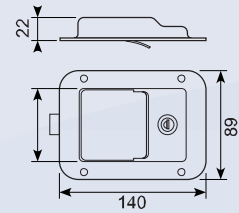

### 15.530A



**Indbygningslås u. knop med aflåsning.**  
**Med nøgle nr. 64001**

Paddle lock locking and no knob.  
With key No. 64001

A: 140 mm  
B: 89 mm  
C: 22 mm

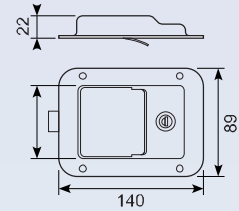

### 15.530S



**Dørlås til indbygning med vippehåndtag**  
**Rustfri stål, med lås, uden knop.**  
**Leveres med sort kunststofunderlag og**  
**2 nøgler.**

Slam-bolt paddle with pierced rim  
Stainless steel, locking, no knob.  
Supplied with black moulded gasket and  
2 keys.

A: 140 mm  
B: 108 mm  
C: 22 mm

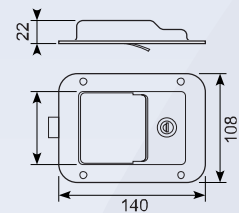

### 15.530SX



**Dørlås til indbygning med vippehåndtag**  
**Rustfri stål, med lås, uden knop.**  
**Leveres med sort kunststofunderlag og 2**  
**nøgler FS880.**

Slam-bolt paddle with pierced rim  
Stainless steel, locking, no knob.  
Supplied with black, moulded gasket and 2  
keys FS880.

A: 140 mm  
B: 108 mm  
C: 22 mm

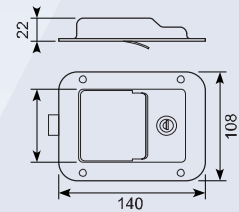

### 15.531



**Dørlås til indbygning med vippehåndtag**  
**El-galvaniseret jern, uden lås, med knop.**  
**Leveres med sort kunststofunderlag.**

Small M/S paddle lock  
Zincplated, non-locking, with knob.  
Supplied with black, moulded gasket.

A: 140 mm  
B: 89 mm  
C: 22 mm  
D: 60 mm

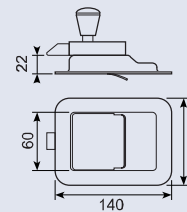

### 15.532



**Dørlås til indbygning med vippehåndtag**  
**El-galvaniseret jern, med lås og knop.**  
**Leveres med sort kunststofunderlag og 2**  
**nøgler.**

Small paddle lock  
Zinc plated, locking, with knob.  
Supplied with black, moulded gasket and  
2 keys.

A: 140 mm  
B: 89 mm  
C: 22 mm  
D: 60 mm

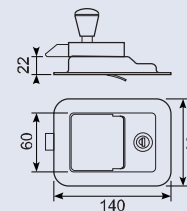

### 15.532J



**Dørlås til indbygning med vippehåndtag**  
**Rustfri stål, med lås og knop.**  
**Leveres med sort kunststofunderlag og 2 nøgler.**

Slam-bolt paddle with pierced rim  
Stainless steel, locking, with knob.  
Supplied with black moulded gasket and 2 keys.

Stainless door lock with 2203 knob seal  
on lock 133 mm long, 5 different key  
combinations.

A: 133 mm  
B: 108 mm  
C: 22 mm

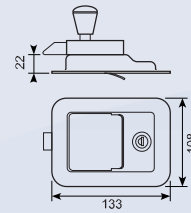

### 15.532R



**Dørlås til indbygning med vippehåndtag**  
**Rustfri stål, med lås og knop.**  
**Leveres med sort kunststofunderlag og 2 nøgler.**

Paddle lock with interior release, flush  
fitting  
Stainless steel, locking, with knob.  
Supplied with black, moulded gasket and 2 keys.

A: 140 mm  
B: 89 mm  
C: 22 mm  
D: 60 mm

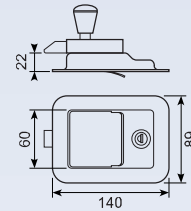

### 15.533

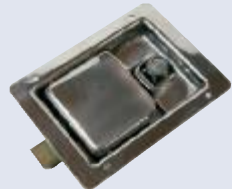

**Dørlås til indbygning med vippehåndtag**  
**Rustfri stål, med lås, uden knop.**  
**Leveres med sort kunststofunderlag og 2 nøgler.**

Slam-bolt paddle with pierced rim  
Stainless steel, locking, no knob.  
Supplied with black, moulded gasket and 2 keys.

A: 140 mm  
B: 108 mm  
C: 22 mm

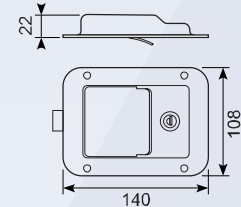

### 15.535AS



**Indbygningsmæklås - aflåselig**  
**Rustfri stål uden indvendigt håndtag.**  
**Låsemekanik i galvaniseret jern**  
**Leveres med 2 stk. nøgler.**

Paddle lock - locking  
Stainless steel, no Interior release  
Clamp plate Zinc-plated, mild steel

A: 140 mm  
B: 108 mm  
C: 22 mm  
D: 78 mm  
E: 110 mm

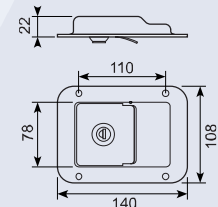

### 15.535BS



**Indbygningsmæklås - aflåselig**  
**Rustfri stål uden indvendigt håndtag.**  
**Låsemekanik i galvaniseret jern**  
**Leveres med 2 stk. nøgler 64001.**

Paddle lock - locking  
Stainless steel, no interior release  
Zinc-plated clamp plate, mild steel  
Incl. 2 keys 64001.

A: 140 mm  
B: 108 mm  
C: 22 mm  
D: 78 mm  
E: 110 mm

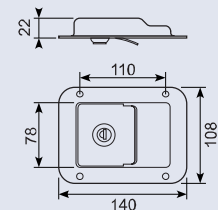

### 15.535CS



**Indbygningsmæklås - aflåselig**  
**Rustfri stål med indvendigt håndtag.**  
**Låsemekanik i galvaniseret jern**  
**Leveres med 2 stk. nøgler 64001.**

Paddle lock - locking  
Stainless steel, interior release  
Zinc-plated clamp plate, mild steel  
Incl. 2 keys 64001.

A: 140 mm  
B: 108 mm  
C: 22 mm  
D: 78 mm  
E: 110 mm

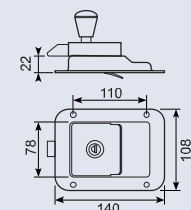

● Godt køb / best buy

**15.536**

**Indbygningssmæklås - aflåselig**  
**Rustfri stål.**  
**Leveres med 2 stk. nøgler.**

Deep-dish paddle - locking  
 Stainless steel. Incl. 2 keys

A: 170 mm  
 B: 110 mm  
 C: 30 mm  
 D: 44 mm  
 E: 142 mm  
 F: 82 mm

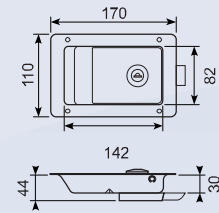
**15.540**

**Indbygningssmæklås - aflåselig**  
**Leveres med 2 stk. nøgler.**  
**Stål med huller i flange og pakning.**  
**Låsepal formet som krog.**

Hook-latch paddle - locking  
 Incl. 2 keys.  
 Steel with pierced flange and gasket  
 Hook-shaped striker.

A: 140 mm  
 B: 108 mm  
 C: 36 mm  
 D: 56 mm

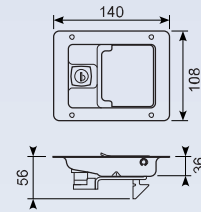
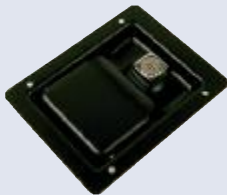
**15.540B**

**Indbygningssmæklås - aflåselig**  
**Leveres med 2 stk. nøgler.**  
**Sort, med huller i flange og pakning**

Hook-latch paddle - locking  
 Incl. 2 keys.  
 Black powder-coated, with pierced flange  
 and gasket

A: 140 mm  
 B: 108 mm  
 C: 36 mm  
 D: 56 mm

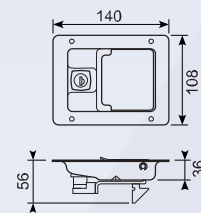
**15.541J**

**Indbygningssmæklås**  
**Rustfri stål uden huller i flange.**  
**Montage med bøjle**

Paddle latch  
 Stainless steel without pierced flange  
 With mounting bracket  
 L x W: 84 x 68 mm  
 Installation: 71,5 x 55,5 mm

A: 84 mm  
 B: 68 mm  
 C: 71,5 mm  
 D: 55,5 mm

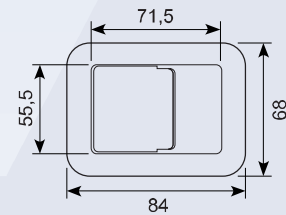
**50.9976**

**Rustfri smæklås 304**

43 x 28 mm

Stainless paddlelock 304

**15.580**

**Lås med vippegreb og 2 gribere**  
**Med aflåsning**  
**Beskyttelsesdæksel for lås**  
**Rustfri stål.**

Paddle handle SS w/lock shutter and cover

Længde: 180 mm  
 Brede: 120 mm

● Godt køb / best buy



## 15.580B



**Bagplade rustfri for 15.580 og 15.581**

180 x 120 mm

Rear plate SS for 15.580 and 15.581

## 15.580S



**Gribplade for 15.580 og 15.581  
Rustfri**

Striker plate SS 304 self color

## 15.580U

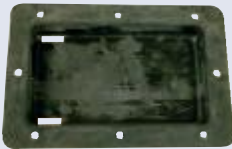

**Gummiunderlag for 15.580 og 15.581**

Rubber uncover "black"

## 15.581



**Lås med vippegreb og 2 gribere  
Uden aflåsning  
Bøjle for hængelås  
Rustfri stål.**

Længde: 180 mm

Bredde: 120 mm

Paddle handle without lock, SS  
Fixture for padlock

## 15.403



**Udvendig låsehåndtag med vippegreb  
Grålakeret - leveres med 2 nøgler.  
Passer til 15.4028 og 15.4025**

Exterior Tractor Lock Assembly  
White flap - with 2 keys.  
Fits 15.4028 and 15.4025

A: 146 mm

B: 76 mm

C: 30 mm

D: 38 mm

E: 25 mm

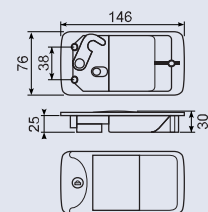

## 15.403S



**Udvendig låsehåndtag med vippegreb  
Sort lakeret - leveres med 2 nøgler.**

Exterior Tractor Lock Assembly  
Black - with 2 keys

A: 146 mm

B: 76 mm

C: 30 mm

D: 38 mm

E: 25 mm

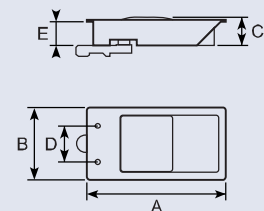

## 15.413



**Udvendig låsehåndtag med vippegreb  
Grålakeret metal - leveres med 2 nøgler.  
Passer til 15.4118 og 15.412**

Caraloc Exterior Assembly  
Grey - with 2 keys  
Fits 15.4111 og 15.412

A: 146 mm

B: 76 mm

C: 30 mm

D: 38 mm

E: 25 mm

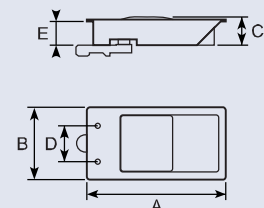

Godt køb / best buy

### 15.417



**Udvendig låsehåndtag med vippegreb**  
**Sortlakeret metal - leveres med 2 nøgler.**

Exterior flap handle assembly  
Black powder-coated metal. Incl. 2 keys.

A: 146 mm  
B: 76 mm  
C: 30 mm  
D: 38 mm  
E: 25 mm

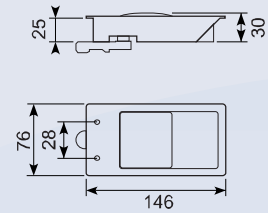

### 15.417P



**Passer til 15.417**

Operating lever for 15.417

### 15.440



**Smæklås - aflåselig**  
**Sortlakeret metal, leveres med 2 nøgler.**  
**Komplet lås til indbygning.**

Paddle handle - locking  
Mild steel, black - with 2 keys

A: 146 mm  
B: 76 mm  
C: 30 mm  
D: 38 mm  
E: 25 mm

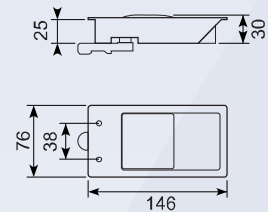

### 15.402



**Indvendig lås med håndtag, grålakeret.**  
**Højre/venstre**  
**Kan ikke låses**  
**Passer til 15.403**

Tractor Lock Interior assembly  
Grey  
Right/left  
Fits for 15.403

A: 100 mm  
B: 92 mm  
C: 51 mm  
D: 38 mm  
E: 19 mm

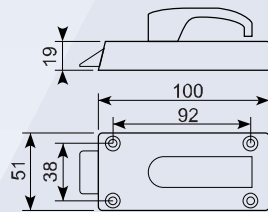

### 15.402S



**Indvendig lås med håndtag**  
**Sortlakeret.**  
**Højre/venstre**  
**Kan ikke låses**  
**Passer til 15.403**

Tractor Lock Interior Assembly  
Black  
Right/left  
Fits 15.403

A: 100 mm  
B: 92 mm  
C: 51 mm  
D: 38 mm  
E: 19 mm

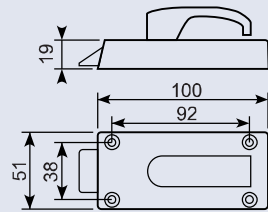

### 15.411



**Indvendig lås med håndtag - venstre**  
**Passer til 15.413**

Interior Caraloc assembly - LH  
Fits 15.413

A: 110 mm  
B: 92 mm  
C: 51 mm  
D: 38 mm  
E: 19 mm

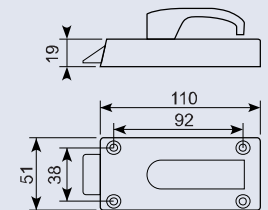



**15.412**

**Indvendig lås med håndtag - højre**  
**Grålakeret metal.**  
**Passer til 15.413**

Interior Caraloc assembly - RH  
 Grey powder-coated metal  
 Fits 15.413

A: 110 mm  
 B: 92 mm  
 C: 51 mm  
 D: 38 mm  
 E: 19 mm

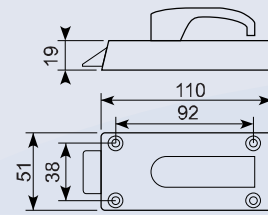
**15.414**

**Bundplade til 15.411, 15.412**  
**Grålakeret metal.**

Base plate for 15.411, 15.412  
 Grey

**15.422**

**Indvendig lås med håndtag**  
**Sort kunststof. Passer til 15.423**

Interior Caraloc Assembly with handle  
 Black, synthetic material. Fits 15.423.

Length: 150 mm  
 Width: 65 mm  
 Height: 40 mm

**15.423**

**Udvendig låsehåndtag med vrider**  
**Sort kunststof - leveres med 2 nøgler.**

Caraloc Exterior Assembly - Full Tang Keys  
 Black, synthetic material - with 2 keys.

Length: 110 mm  
 Width: 110 mm  
 Height: 10 mm

**15.570**

**T-drop dørlås til indbygning**  
**Rustfrit stål, med lås og indfældbart greb.**  
**Leveres med 2 nøgler FS880.**

Drop-T Single-Point latch - RH  
 Stainless steel, locking, with cranked down latch bar.  
 Supplied with 2 keys.

A: 125 mm  
 B: 120 mm  
 C: 68 mm

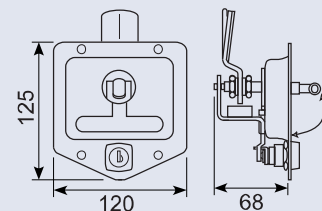
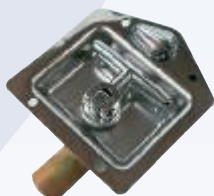
**15.560E**

**T-drop 1-punkt, aflåselig med nøgleklap**  
**Rustfrit stål til indbygning**  
**Leveres med pakning.**

Drop-T single-point latch with weathershield  
 Polished stainless steel  
 With gasket

A: 125 mm  
 B: 120 mm  
 C: 68 mm

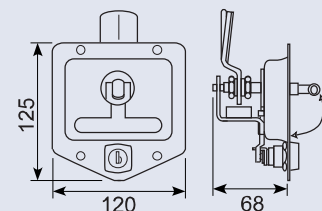
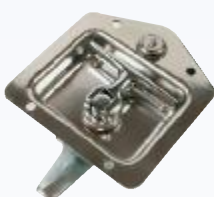
**15.560**

**T-drop 1-punkt - venstre**  
**Rustfrit stål til indbygning**  
**For stang/pal med lås.**  
**Leveres med pakning**

Drop-T single-point latch - LH  
 Polished stainless steel  
 With gasket

A: 125 mm  
 B: 120 mm  
 C: 68 mm

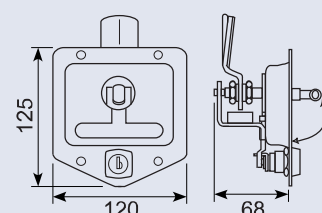

15.550

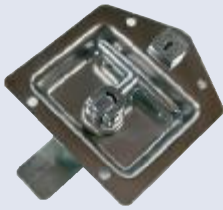

**T-drop 3-punkt aflåselig**  
**Poleret rustfrit stål til indbygning**  
**For stang/pal, leveres med nøgle**

Drop-T 3-way latch system  
 Polished stainless steel  
 Supplied with rods and guides. Incl. key

A: 125 mm  
 B: 120 mm  
 C: 45 mm

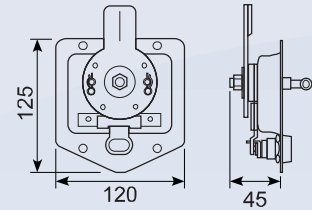

15.559J



**T-drop 3-punkt**  
**Poleret rustfrit stål til indbygning.**

Drop-T 3-way latch system  
 Polished stainless steel  
 w/o locks and locking-hole

A: 125 mm  
 B: 120 mm  
 C: 45 mm

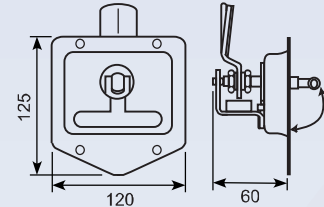

15.560J



**T-drop 3-punkt, aflåselig**  
**Poleret rustfrit stål til indbygning**  
**Leveres med nøgle CH545**

Drop-T 3-way latch, locking  
 Polished stainless steel  
 Incl. key CH545

A: 125 mm  
 B: 120 mm  
 C: 65 mm

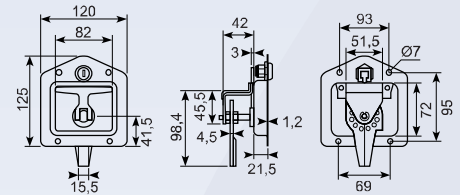

15.424L



**Lås, venstre model**

Turn lock with connection pins 580 + 705 mm, left model

Bredde: 100 mm  
 Højde: 88 mm  
 Dybde: 25 mm

15.424R



**Lås, højre model**

Turn lock with 2 connection pins 580 + 705 mm, right model

Bredde: 100 mm  
 Højde: 88 mm  
 Dybde: 25 mm

16.216M

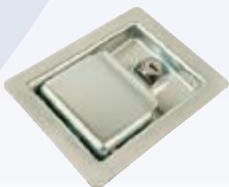

**Indbygningshåndtag stål med vippegreb**  
**Anvendes til to-vejs stanglås.**  
**Med lås - leveres med 2 nøgler.**  
**FS880.**

Paddle - 2-way model - Stainless steel.  
 Mild steel model with plain rim  
 Locking - with two keys

A: 140 mm  
 B: 108 mm  
 C: 56 mm

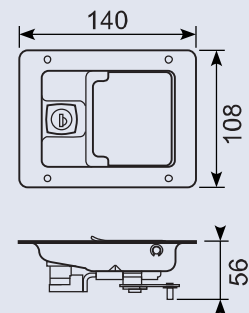

● Godt køb / best buy

## 16.216MR



2-vejs indbygningslås, rustfri med underlag af kunststof. Incl. 2 nøgler FS880.

Paddle handle with pierced flange  
With 2-way mechanism  
Polished stainless steel with lock and moulded gasket. Incl. 2 keys FS880.

A: 140 mm  
B: 108 mm  
C: 56 mm

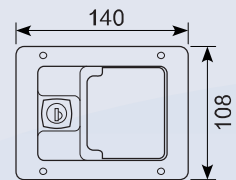

## 16.216S

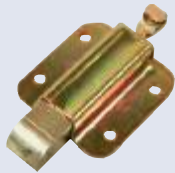

Snåplås til 16.216M

End-latch, quick-fit pull, nose-down  
For 16.216M

A: 62 mm  
B: 57 mm  
C: 33 mm  
D: 44,5 mm  
E: 13 mm  
F: 19 mm  
G: 6 mm  
H: 11 mm  
I: 4 mm

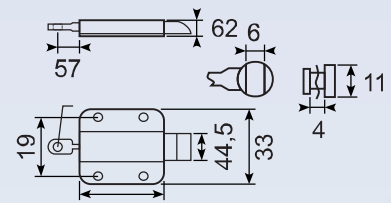

## 16.216ST

Trækstang til 16.216M og 16.216MR

Længde: 915 mm

Linkage bar for 16.216M  
and 16.216MR



## 16.216U

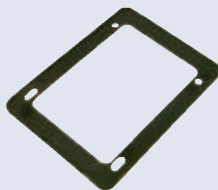

Kunststofunderlag til  
16.216MR, 16.216M og 15.530

Gasket for  
16.216MR, 16.216M og 15.530

## 16.221

3-punkt stanglås til 8 mm stift, højre  
Anvendes til lette døre. Komplet sæt  
indeholdende:  
Låseplade med tungelås samt låseblink og  
2 skudrigler med styr  
Galvaniseret jern

3-way rod latch (set), RH  
For light doors. Includes guides and keeper  
plate  
Yellow zinc-plated. Rod: dia. 10 mm  
Total length: 2000 mm

Stænger: Ø 10 mm  
Total længde: 2000  
mm  
A: 2264/2230  
B: 145 mm  
C: 36 mm  
D: 54/21 mm  
E: 40 mm  
F: 25 mm

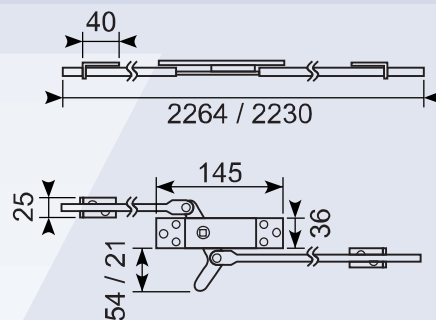

Stænger: Ø 10 mm  
Total længde: 2000 mm



### 16.222

3-punkt stanglås til 8 mm stift, venstre  
Anvendes til lette døre. Komplet sæt  
indeholdende:

Låseplade med tungelås samt låseblæk og  
2 skudrigler med styr

Galvaniseret jern

3-way rod latch (set), LH

For light doors. Includes guides and keeper  
plate

Yellow zinc-plated. Rod: dia. 10 mm

Total length: 2000 mm

Stænger: Ø 10 mm  
Total længde: 2000  
mm

A: 2264/2230

B: 145 mm

C: 36 mm

D: 54/21 mm

E: 40 mm

F: 25 mm

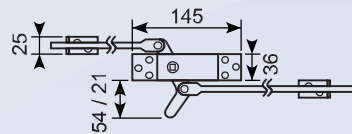
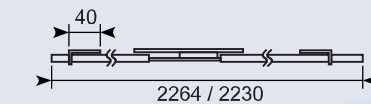

Stænger: Ø 10 mm  
Total længde: 2000 mm



### 16.224H

Stanglås til 8 mm stift, højre

Med firkantet midterlås. Komplet sæt  
indeholdende: Låseplade, 2 stænger og 2  
snaplåse

Galvaniseret jern

2-way rod latch (set), RH

Includes guides. Yellow zinc-plated

Rod: diameter 10 mm

Total length: 2160/2210 mm

A: 2160/2210 mm

Stænger: Ø10 mm

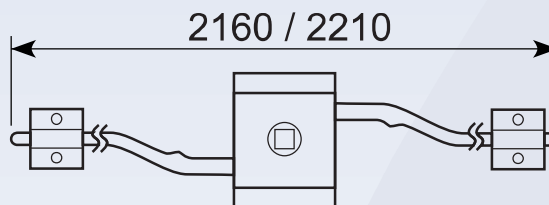

Stænger: Ø 10 mm



### 16.224V

Stanglås til 8 mm stift, venstre

Med firkantet midterlås. Komplet sæt  
indeholdende: Låseplade, 2 stænger og 2  
snaplåse

Galvaniseret jern

2-way rod latch (set), LH

Includes guides.

Yellow zinc-plated.

Rod: diameter 10 mm

Total length: 2160/2210 mm

A: 2160/2210 mm

Stænger: Ø10 mm

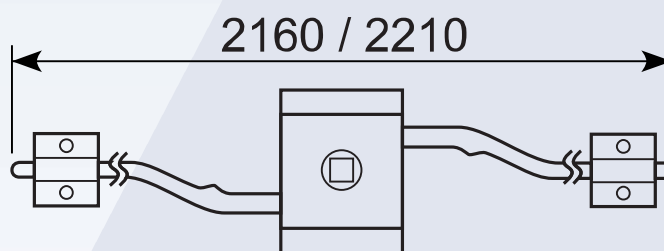

Stænger: Ø 10 mm

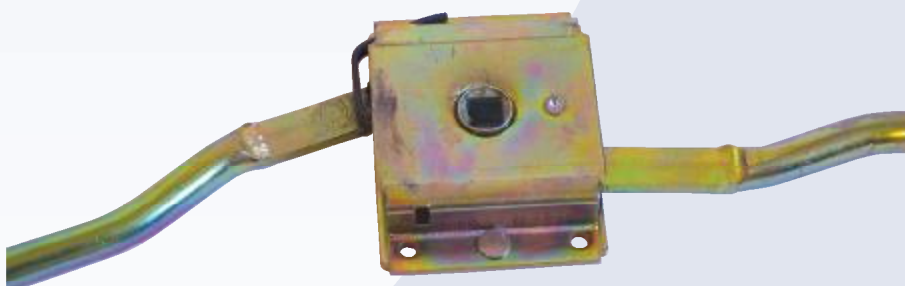

## 16.226

3-punkt stanglås til 8 mm stift, højre  
Komplet sæt indeholdende: Låseplade med  
tungelås samt låseblæk, 2 stænger med  
styr og 2 snaplås med endebeslag  
Galvaniseret jern

3-way slam system, RH  
Complete set including guides, strikers,  
rivets and wave washers  
Yellow zinc-plated  
Linkage bar section: 12 x 3 mm

A: 2057 mm  
B: 25 mm  
C: 40 mm  
D: 915 mm

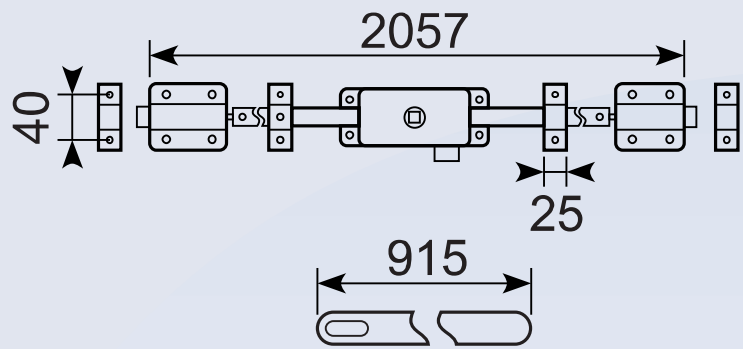

## 16.256

Midterlås med lukket kasse - venstre  
Galvaniseret, til 8 mm stift.

Længde: 125 mm  
Bredde: 58 mm  
Højde: 14 mm



Bolt lock - LH  
Zinc-plated steel

## 16.257

Midterlås højre

Bolt lock, right



## 16.267

Midterlås med lukket kasse og lås  
- højre  
Galvaniseret, til 8 mm stift.

Længde: 125 mm  
Bredde: 60 mm  
Højde: 30 mm



Bolt lock - RH  
Zinc-plated for 8 mm pin

## 16.267V

Midterlås med lukket kasse og lås  
- venstre  
Galvaniseret, til 8 mm stift.

Længde: 125 mm  
Bredde: 60 mm  
Højde: 30 mm



Bolt lock - LH  
Zinc-plated for 8 mm pin

## 16.232M

Midterlås med sikring  
Sortlakeret.

40 x 170 mm



Bolt casing with support plate  
Black

## 16.236M

Midterlås med vendbart greb  
Forsat greb, der kun kan åbnes udad.  
Sortlakeret.

40 x 170 mm



Bolt catch with side handle for square rod  
Black painted steel

## 16.231

Stænger til 16.232M og 16.236M

Dim. 11 x 11 mm  
Længde 1500 mm

Square rod for 16232M and 16.236M



## 16.231F

Beslag til stang 16.231.  
10 mm

Runner with base plate for 16.231.  
10 mm



## 16.232S

Stænger til 16.232M og 16.236M

Dim.: 10 x 10 mm  
Længde: 1500 mm

Square rod for 16232M and 16.236M



## 16.232B

Beslag til stang 16.232.  
11 mm

Runner with base plate for 16.232  
11 mm



## Truck- og kabinelåse / Truck and cabinet locks

23.331



**Bøjlegreb med sikring - venstre.  
Sortlakeret metalhåndtag med trykudløser.  
Komplet - anvendes til bla. truckdøre.**

Cabdoor latch with safety device - LH  
Black metal handle with pressure release.  
Complete - used for e.g. fork-lift truck doors.

A: 84 mm  
B: 18 mm  
C: 14 mm  
D: 29 mm  
E: 55 mm  
F: 47,5 mm  
G: 14,5 mm

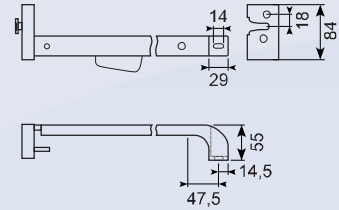

23.332



**Bøjlegreb med sikring - højre.  
Sortlakeret metalhåndtag med trykudløser.  
Komplet - anvendes til bla. truckdøre.**

Cabdoor latch with safety device - RH  
Black metal handle with pressure release.  
Complete - used for e.g. fork-lift truck doors.

A: 84 mm  
B: 18 mm  
C: 14 mm  
D: 29 mm  
E: 55 mm  
F: 47,5 mm  
G: 14,5 mm

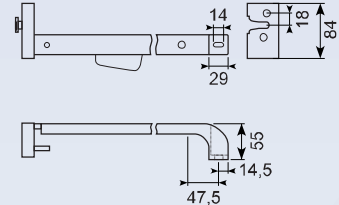

23.333



**Bøjlegreb uden sikring - venstre  
Sortlakeret metalhåndtag med trykudløser.  
Komplet - anvendes til bla. trucksdøre.**

Cabdoor latch without safety device - LH  
Black metal handle with pressure release.  
Complete - used for e.g. fork-lift truck doors.

A: 84 mm  
B: 18 mm  
C: 14 mm  
D: 29 mm  
E: 55 mm  
F: 47,5 mm  
G: 14,5 mm  
Rørlængde: 435 mm

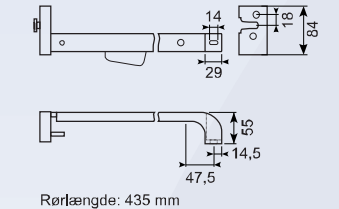

23.334



**Bøjlegreb uden sikring - højre  
Sortlakeret metalhåndtag med trykudløser.  
Komplet - anvendes til bla. truckdøre.**

Cabdoor latch without safety device - RH  
Black metal handle with pressure release.  
Complete - used for e.g. fork-lift truck doors.

A: 84 mm  
B: 18 mm  
C: 14 mm  
D: 29 mm  
E: 55 mm  
F: 47,5 mm  
G: 14,5 mm  
Rørlængde: 435 mm

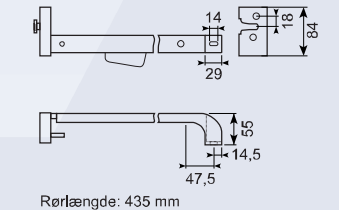

23.334B



**Pladeafdækning for bøjlegreb**

Plate covering for cabdoor latch 23.334

10.483

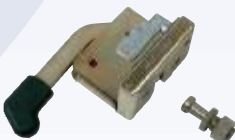

**Kabinelås med håndtag - venstre  
EI-galvaniseret incl. låsebolt.**

Cab-door latch with handle - LH  
Zinc-plated incl. striker

## 10.483P

### Låseplade for kabinelås 10.483

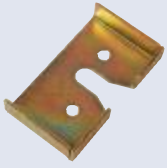

Face fixing plate for cab-door latch  
10.483

## 10.484

### Kabinelås med håndtag - højre El-galvaniseret, incl. låsebolt.



Cab-door latch with handle - RH  
Zinc-plated, incl. striker

## 10.484P

### Låseplade for kabinelås 10.484



Face fixing plate for cab-door latch  
10.484

## 22.315

### Låsebolt 18/42 mm for 10.483 og 10.484

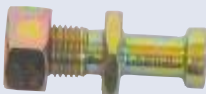

Locking bolt 18/42 mm for 10.483 and  
10.484

## 15.501

### Indvendig dørlås uden sikring - venstre El-galvaniseret metal. Passer til 10.600



Interior cabdoor latch without safety device  
- LH  
Zinc plated  
Fits 10.600

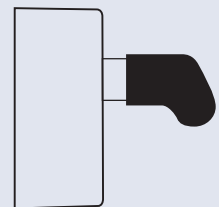
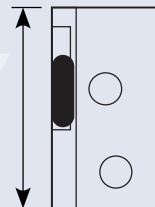

## 15.502

### Indvendig dørlås uden sikring - højre El-galvaniseret metal. Passer til 10.600



Interior cabdoor latch without safety device  
- RH  
Zinc plated  
Fits 10.600



## 15.503

### Indvendig dørlås uden sikring - venstre El-galvaniseret metal med udløserarm.



Cabdoor lock, non-locking without safety device - LH  
Zincplated, with release lever

A: 74 mm  
B: 65 mm  
C: 34,5 mm  
D: 28,5 mm  
E: 17 mm  
F: 45 mm  
G: 39 mm  
H: 23,5 mm  
I: 25 mm  
J: 10 mm

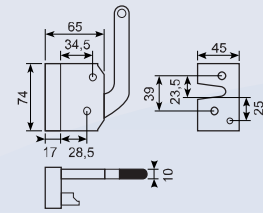

## 15.509

### Indvendig dørlås uden sikring - venstre El-galvaniseret metal med forsat PVC håndtag. Passer til 10.600

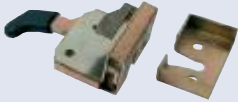

Interior cabdoor latch without safety device - LH  
for small to medium doors, zinc-plated  
Fits 10.600

A: 74 mm  
B: 65 mm  
C: 34,5 mm  
D: 28,5 mm  
E: 17 mm  
F: 45 mm  
G: 39 mm  
H: 23,5 mm  
I: 25 mm  
J: 10 mm

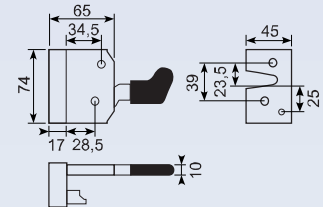

## 15.510

### Indvendig dørlås uden sikring - højre.



Interior cabdoor latch without safety device - RH

A: 74 mm  
B: 65 mm  
C: 34,5 mm  
D: 28,5 mm  
E: 17 mm  
F: 45 mm  
G: 39 mm  
H: 23,5 mm  
I: 25 mm  
J: 10 mm

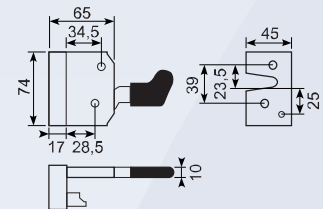

## 15.513

### Indvendig dørlås uden sikring - venstre. El-galvaniseret metal med PVC håndtag. Passer til 10.600 og 10.640



Interior cabdoor latch without safety device - LH  
for small to medium doors, zinc-plated, with PVC-handle  
Fits 10.600 and 10.640

A: 74 mm  
B: 65 mm  
C: 34,5 mm  
D: 28,5 mm  
E: 17 mm  
F: 45 mm  
G: 39 mm  
H: 23,5 mm  
I: 25 mm  
J: 10 mm



## 15.514

### Indvendig dørlås uden sikring - højre. El-galvaniseret metal med PVC håndtag. Passer til 10.600 og 10.640

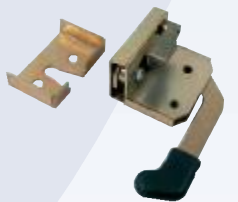

Interior cabdoor latch without safety device - RH  
for small to medium doors, zinc plated  
Fits 10.600 and 10.640

A: 74 mm  
B: 65 mm  
C: 34,5 mm  
D: 28,5 mm  
E: 17 mm  
F: 45 mm  
G: 39 mm  
H: 23,5 mm  
I: 25 mm  
J: 10 mm

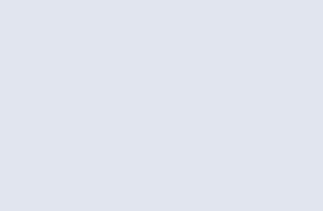

## 15.517

### Indvendig dørlås med sikring - venstre. El-galvaniseret metal med lige PVC håndtag. Passer til 10.600 og 10.640.

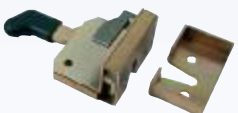

Interior cabdoor latch with safety device - LH  
Zinc-plated, with straight handle  
Fits 10.600 and 10.640

A: 146 mm  
B: 76 mm  
C: 30 mm  
D: 38 mm  
E: 25 mm

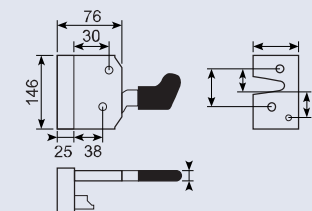

**15.519**

**Indvendig dørlås uden sikring - venstre.**  
**EI-galvaniseret metal med lige PVC**  
**håndtag.**  
**Passer til 10.600 og 10.640**

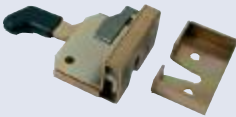

Interior cabdoor latch without safety device  
 - LH  
 Zinc-plated, with straight handle  
 Fits 10.600 and 10.640

**15.481**

**Traktordørlås - venstre**  
**Smæklås med vippehåndtag**  
**Galvaniseret jern.**  
**Stift: 8 mm. PVC.**



Slam latch - LH  
 With handle, zinc-plated

A: 80 mm  
 B: 21 mm  
 C: 165 mm  
 D: 26 mm  
 E: 65 mm  
 F: 19 mm  
 G: 72 mm  
 H: 19 mm

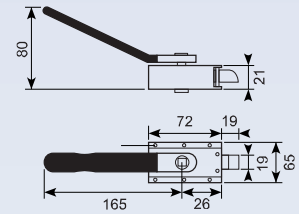
**15.482**

**Traktordørlås - højre**  
**Smæklås med vippehåndtag.**  
**Galvaniseret jern.**  
**Stift: 8 mm PVC.**



Slam latch - RH  
 With handle, zinc-plated

A: 80 mm  
 B: 21 mm  
 C: 165 mm  
 D: 26 mm  
 E: 65 mm  
 F: 19 mm  
 G: 72 mm  
 H: 19 mm

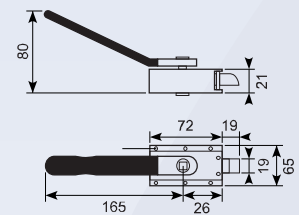
**16.215**

**Snaplås, metal højre topmonteret**  
**EI-galvaniseret jern - til kabel.**



Claw latch, RH, top mount  
 Yellow zinc-plated - for cable

A: 100 mm  
 B: 82 mm  
 C: 50 mm  
 D: 30 mm  
 E: 19 mm  
 F: 21 mm

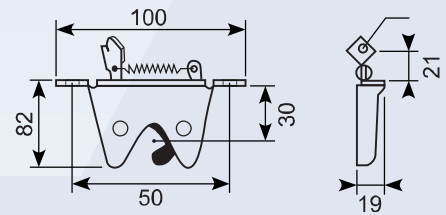
**16.218**

**Snaplås, metal sidemonteret**  
**EI-galvaniseret jern - til kabel.**



Claw latch, RH, side mount  
 Yellow zinc-plated - for cable

A: 100 mm  
 B: 76 mm  
 C: 50 mm  
 D: 30 mm  
 E: 19 mm  
 F: 21 mm

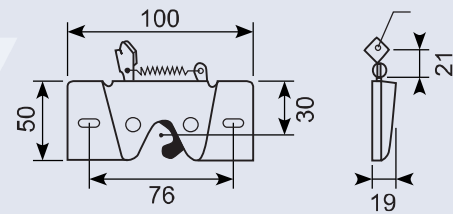
**16.215B**

**Plastafdækning**  
**for 16.215/16.218**



Moulded buffer for 16.215/16.218

**16.215F**

**Fjeder til snaplås 16.215/16.218**



Spring for latch 16.215/16.218

## 16.215T



### Låsetap til snaplås 16.215/16.218 El-galvaniseret metal.

Pin-striker, 52 mm for  
16.215/16.218  
Yellow zinc-plated

A: 51 mm  
B: 32 mm  
C: 32 mm  
D: 52 mm  
E: 51 mm  
F: 3 mm

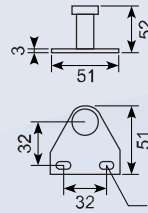

## 15.491



### Traktorlås venstre Indvendig lås, kan anvendes med to håndtag. Galvaniseret jern.

Rotary latch - LH  
Interior latch, may be used with two handles  
Zinc-plated.

A: 21 mm  
B: 92 mm  
C: 59 mm  
D: 40 mm  
E: 20 mm  
F: 55°  
G: Ø8 mm

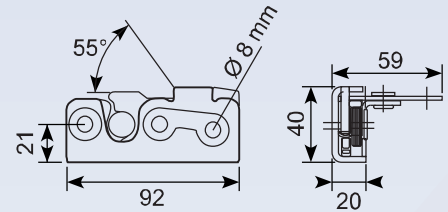

## 15.492



### Traktorlås højre Indvendig lås, kan anvendes med to håndtag. Galvaniseret jern.

Rotary latch - RH  
Interior latch, may be used with two handles  
Zinc-plated.

A: 21 mm  
B: 92 mm  
C: 59 mm  
D: 40 mm  
E: 20 mm  
F: 55°  
G: Ø8 mm

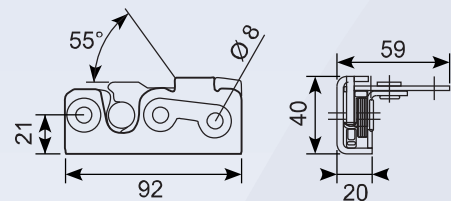

## 15.51700



### Lås for sidelåger m.v. venstre

Forked lock for side gate, LH, zinc-plated

Bredde: 43 mm  
Længde: 85 mm

## 15.66940



### Lås for sidelåger m.v. højre

Forked lock for side gate RH, zinc-plated

Bredde: 43 mm  
Længde 85 mm

## 15.527



### Indvendig lås med udløser - venstre Galvaniseret jern med sort plastafdækning. Plastbetrukket håndtag Passer også til 15.417

Tractor lock interior assembly - LH  
Zinc-plated iron with black plastic cover  
Fits 15.417

A: 47 mm  
B: 80 mm  
C: 127 mm

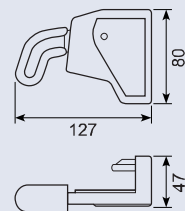

## 15.528



### Indvendig lås med udløser - højre. Som 15.527.

Tractor lock interior assembly - RH

A: 47 mm  
B: 80 mm  
C: 127 mm

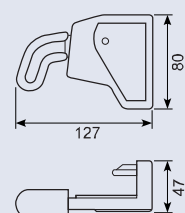

## 22.300



**Låsebolt - galvaniseret jern**  
Passer også til 15.527 og 15.528

Gevind: 12 mm

Stud, locking - zinc-plated  
Also fits 15.527 and 15.528

## 22.301

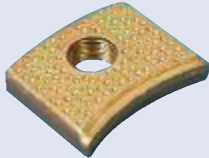

**Gevindplade for låsebolt - gevind 12 mm**

Plate for striker - 12 mm thread

## 22.310

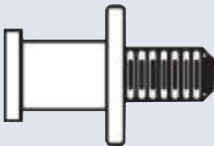

**Låsebolt til traktorlås**  
Passer til 15.491 og 15.492

Striker pin for rotary latch  
Fits 15.491 and 15.492

## 22.312



**Låsebolt - galvaniseret jern**  
Passer også til 15.527, 15.528, 22.300 og 22.3515

Bolt: Ø 9,85  
Gevind: M12 x 1

Stud, locking - zinc-plated  
Also fits 15.527, 15.528, 22.300 and 22.3515.

## 15.323



**Udløserhåndtag med vippegreb**  
Sort kunststof med metalgreb.

Buckle Inside Release Handle, chrome with snap-in connector, black synthetic material

A: 102 mm  
B: 61 mm  
C: 20 mm

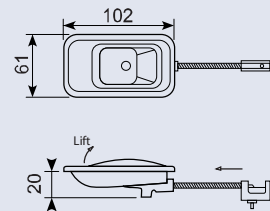

## 15.324



**Bagplade for 15.323 udløserhåndtag**

Escutcheon bowl for 15.323 release handle

## 15.430



**passer til 15.417**

Paddle handle  
Black, with moulded gasket  
Incl. 2 keys

L: 133 mm  
B: 76 mm  
H: 48 mm

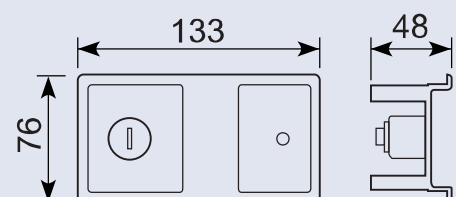

## 15.430U

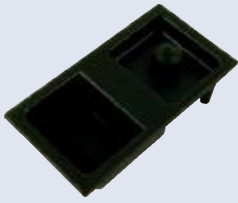

### Underlag for 15.430

Rubber gasket for paddle handle 15.430.

## 15.446



### Indvendig dørlås uden sikring - højre El-galvaniseret metal.

Disc latch (push-button model) RH  
Zinc plated.

A: 66 mm  
B: 94 mm  
C: 18 mm

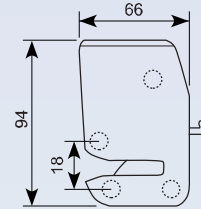

## 15.447



### Indvendig dørlås uden sikring - højre El-galvaniseret metal.

Disc latch (push-button model) - RH, zinc  
plated.

A: 66 mm  
B: 94 mm  
C: 18 mm

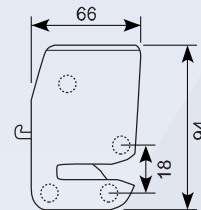

## 28.116

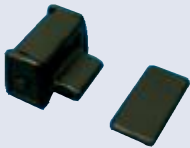

### Skyderudelås Sort kunststof, til gennemboring Komplet med pakning.

Sliding Window Catch  
Black plastic, with PVC backing  
pieces

## 28.135

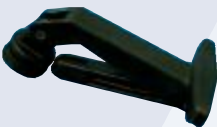

### Vipperude-hatch Sort kunststof, til gennemboring. Kliklås i håndtaget.

Overcentre Window Stay  
Black synthetic material  
Locks in various opening positions

A: 132 mm  
B: 94 mm  
C: 17 mm  
D: 200 mm  
E: 6 mm  
F: 25 mm

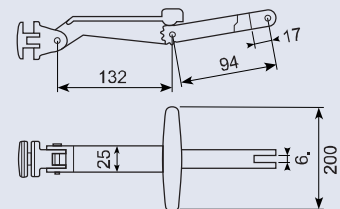

15.505



**Indvendig kasselås uden sikring - venstre side**  
**El-galvaniseret metal med lakeret håndtag.**  
**Til 8 mm stift**

Interior Slam lock, without safety device - LH  
 Zinc-plated metal with PVC dip-coated handle

A: 70 mm  
 B: 87 mm  
 C: 16 mm  
 D: 42 mm  
 E: 16 mm  
 F: 80 mm  
 G: 7 mm  
 H: 5 mm

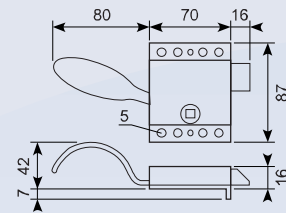

15.506



**Indvendig kasselås uden sikring - højre side**  
**El-galvaniseret metal med lakeret håndtag.**  
**Til 8 mm stift**

Interior Slam lock, without safety device - RH  
 Zinc-plated with PVC dip-coated handle

A: 70 mm  
 B: 87 mm  
 C: 16 mm  
 D: 42 mm  
 E: 16 mm  
 F: 80 mm  
 G: 7 mm  
 H: 5 mm

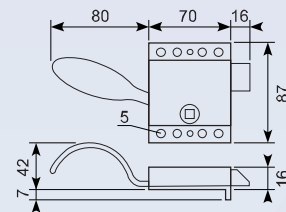

15.508



**Indvendig kasselås med sikring - vendbar**  
**El-galvaniseret metal med lakeret håndtag.**  
**8 mm stift**

Spoon-handle latch - turnable  
 Zinc plated with dip-coated handle

A: 53 mm  
 B: 10 mm  
 C: 20 mm  
 D: 19 mm  
 E: 85 mm  
 F: 45 mm  
 G: 100 mm  
 H: 13 mm  
 J: 6 mm

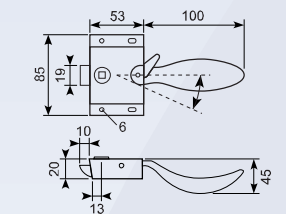

15.511



**Indvendig kasselås med greb - venstre.**  
**El-galvaniseret metal med lakeret håndtag.**  
**Uden sikring. Til 8 mm stift**

Interior slam lock with handle without safety device - LH  
 Zinc-plated with plastic dip-coated handle

A: 92 mm  
 B: 65 mm  
 C: 27 mm  
 D: 46 mm  
 E: 17 mm  
 F: 90 mm

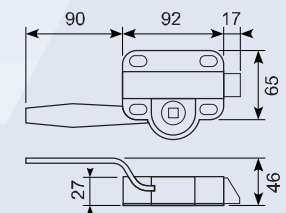

15.512



**Indvendig kasselås med greb - højre.**  
**El-galvaniseret metal med lakeret håndtag.**  
**Uden sikring. Til 8 mm stift**

Interior slam lock with handle, without safety device - RH  
 Zinc-plated with plastic dip-coated handle

A: 92 mm  
 B: 65 mm  
 C: 27 mm  
 D: 46 mm  
 E: 17 mm  
 F: 90 mm

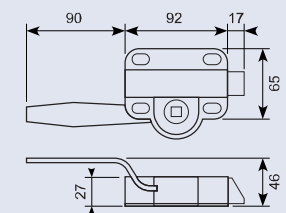

15.515



**Indvendig kasselås - venstre.**  
**El-galvaniseret metal med lakeret håndtag.**  
**Uden sikring. Til 8 mm stift**

Interior slam lock, without safety device - LH  
 Zinc-plated with plastic dip-coated handle

A: 92 mm  
 B: 65 mm  
 C: 27 mm  
 D: 17 mm

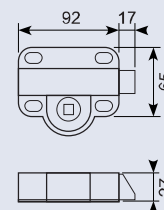

15.516



**Indvendig kasselås - højre.**  
**El-galvaniseret metal med lakeret håndtag.**  
**Uden sikring. Til 8 mm stift**

Interior slam lock, without safety device - RH  
 Zinc-plated with plastic dip-coated handle

A: 92 mm  
 B: 65 mm  
 C: 27 mm  
 D: 17 mm

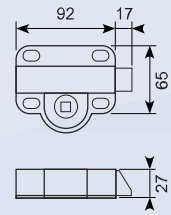

15.521

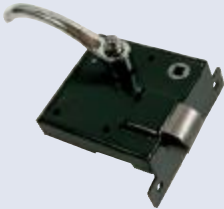

**Indvendig kasselås med sikring - venstre.**  
**El-galvaniseret metal med blankt håndtag.**  
**Til 8 mm stift**

Cab Screw-on Lock, with safety device - LH  
 Zinc-plated with chrome-plated handle

A: 44 mm  
 B: 120 mm  
 C: 96 mm  
 D: 94 mm  
 E: 33 mm  
 F: 20 mm  
 G: Ø6 mm  
 H: Ø4,8 mm

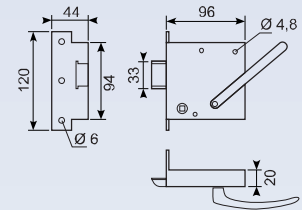

15.522



**Indvendig kasselås med sikring - højre.**  
**El-galvaniseret metal med blankt håndtag.**  
**Til 8 mm stift**

Internal cab screw-on lock, with safety catch - RH  
 Zinc-plated with chrome-plated handle

A: 44 mm  
 B: 120 mm  
 C: 96 mm  
 D: 94 mm  
 E: 33 mm  
 F: 20 mm  
 G: Ø6 mm  
 H: Ø4,8 mm

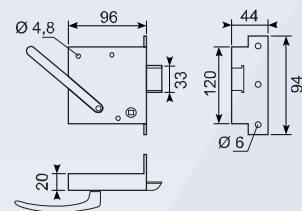

16.163

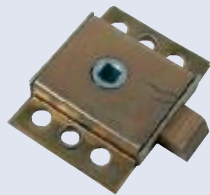

**Indvendig kuffertlås uden sikring - vendbar**  
**Metal - galvaniseret - til 8 mm stift.**

Utility Slam Latch, without safety catch  
 Useable on left or right.

A: 80 mm  
 B: 60 mm  
 C: 14 mm  
 D: 60 mm  
 E: 32 mm

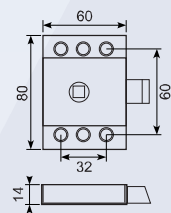

16.165G

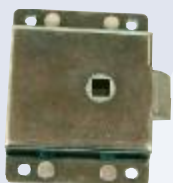

**Indvendig kuffertlås uden sikring - vendbar**  
**Galvaniseret metal**

Screw-on Latch Lock, without safety catch, reversible  
 Zinc plated  
 Screw-on latch lock, useable on left or right

A: 87 mm  
 B: 68 mm  
 C: 18 mm

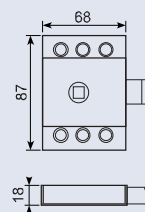

16.183



**Indvendig skydedørslås med pal på 2 sider**  
**Galvaniseret metal , 8 mm stift samt sikring.**

Sliding door lock with latch on two sides  
 Zinc plated metal, 8 mm pin and safety catch

A: 4,12 in.  
 B: 2 in.  
 C: 3,62 in.  
 D: 1,38 in.  
 E: 2,31 in.  
 F: 0,36 in.  
 G: 0,32 in.SQ

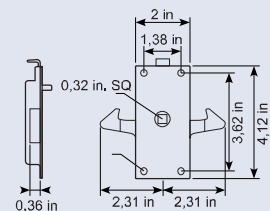

15.448



**Indvendig skydedørslås uden sikring - højre**  
**Sortlakeret metal med håndtag. Til 8 mm stift**

Sliding door lock, without safety catch - RH  
 Black painted steel, with lever

A: 60 mm  
 B: 154 mm  
 C: 18 mm  
 D: 125 mm  
 E: 5,3 mm

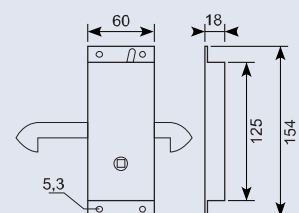

● Godt køb / best buy

15.449



**Indvendig skydedørslås uden sikring  
- venstre  
Sortlakeret metal med håndtag.  
Til 8 mm stift**

Sliding door lock, without safety catch - LH  
Black painted steel, with lever

A: 60 mm  
B: 154 mm  
C: 18 mm  
D: 125 mm  
E: 5,3 mm

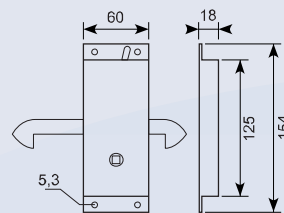

15.450



**Låseblæk til 15.448 og 15449**

Latch Retention Plate for 15.448 and  
15.449



## Kabinet- og handskerumlåse / Compartment locks

16.362F



**Handskerumlås med firkantet front 180° Alloy/chrom med 2 nøgler FS880.**

Deluxe lock. 180° rotation with keys FS880

A: 19 mm  
B: 37 mm  
C: 21 mm  
D: 27 mm  
E: 15 mm  
F: 11 mm  
G: 8 mm

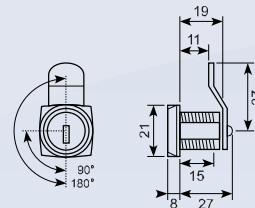

16.362S



**Handskerumlås med rund front 180° Alloy/chrom med 2 nøgler.**

Compartment lock 1/27902 with FS880 key

A: 19 mm  
B: 37 mm  
C: 26 mm  
D: 28 mm  
E: 15 mm  
F: 11 mm  
G: 6 mm

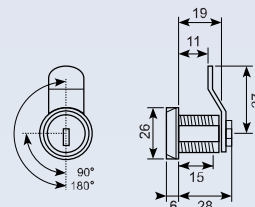

16.363



**Handskerumlås med rund front Alloy/chrom med sortlakeret fast nøgle**

Fixed-key lock Black and chrome

A: 32 mm  
B: 20 mm  
C: 25 mm  
D: 6 mm  
D1: 13 mm  
E: 37 mm

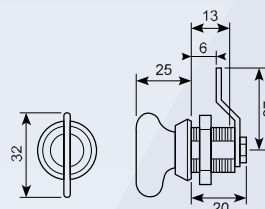

16.364



**Handskerumlås med rund front Alloy/chrom med 2 nøgler 180° rotation**

Lock mixed keys with shutter Alloy and chrome with 2 keys. 180° rotation

A: 19 mm  
B: 37 mm  
C: 26 mm  
D: 28 mm  
E: 16 mm  
F: 11 mm  
G: 6 mm

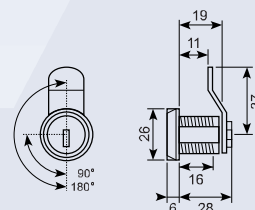

16.400



**Skibokslås til indbygning Sort kunststof med fjederbelastet lås Leveres med 2 nøgler**

Handle for e.g. ski box Black synthetic material Incl. 2 keys.

Max. pladetykkelse 6,5 mm.  
Hulafstand 46 mm.  
Montagehul: Ø35 mm  
A: 58 mm  
B: 65 mm

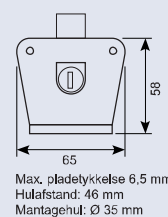

Max. pladetykkelse 6,5 mm  
Hulafstand: 46 mm  
Montagehul. Ø 35 mm

16.401



**Kabinetlås Flad tunge effektiv 34 mm M19x1.0 Alloy/chrom med 2 nøgler**

Baton alloy cam lock 5/8" with 2 keys, end nut

Ø23,2 mm  
L: 16 mm

● Godt køb / best buy

### 16.403



**Kabinetlås**  
**Flad tunge effektiv 34 mm M19x1.0**  
**Alloy/chrom med 2 nøgler**

Baton alloy cam lock 7/8" with 2 keys, end nut

A: 23,2 mm  
 B: 29 mm  
 C: 5 mm  
 D: 24,8 mm  
 E: M19 mm x 1 mm

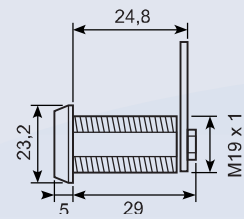

### 16.405



**Kabinetlås**  
**Flad tunge effektiv 34 mm M19 x 1,0 mm**  
**Alloy/chrom med 2 nøgler.**

Baton alloy cam lock, 28 mm with 2 keys, end nut

A: 23,2 mm  
 B: 35 mm  
 C: 5 mm  
 D: 30,5 mm  
 E: M19 x 1 mm

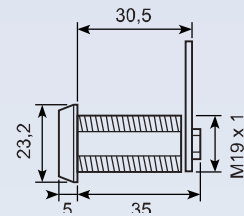

### 18.02100100



**Handskerumslås med rund front 90°**  
**Alloy/krom med 2 nøgler**

Deluxe lock, 90° rotation  
 Mixed keys

A: 32 mm  
 B: 38 mm  
 C: 5 mm  
 D: 29 mm  
 E: Ø20 mm

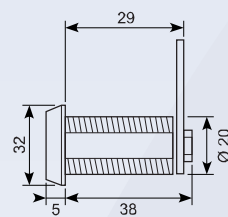

### 18.02103100



**Handskerumslås med rund front 90°**  
**Alloy/krom med 2 nøgler**

Deluxe lock. 90° rotation  
 Mixed keys

A: 32 mm  
 B: 48 mm  
 C: 5 mm  
 D: 39 mm  
 E: Ø 20 mm

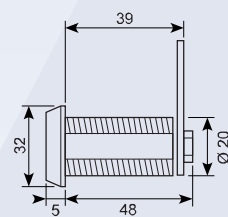

### 16.414



**Kabinetlås 3 mm bits flad tunge**  
**Effektiv 45,4 mm M22 x 1,5 mm, forkromet**

Spanner lock, double bits 3mm

Ø27,7 mm  
 L: 18 mm

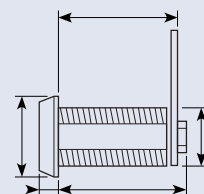

### 16.415



**Kabinetlås 5 mm bits flad tunge**  
**Effektiv 45,4 mm M22 x 1,5 mm, forkromet**

Spanner lock, double bits 5 mm, chrome-plated

A: 27,7 mm  
 B: 27 mm  
 C: 4,5 mm  
 D: 21,8 mm  
 E: M20 x 1,5 mm

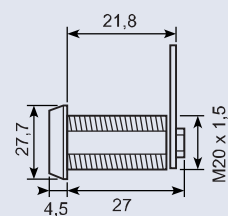

### 18.0213220



**Kabinetlås - lang**  
**Forkromet alloy**

Compartment lock - long  
 Chromium-plated

Mont. hul: Ø22 mm  
 Pladetykkelse: max 30 mm  
 Udv. Ø28 mm

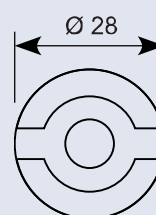

● Godt køb / best buy

18.0261010



**Kabinetlås - kort**  
**Forkromet alloy**

Compartment lock - short  
Chromium-plated

Mont. hul: Ø 22 mm  
Pladetykkelse: max  
8,5 mm  
Udv. Ø 28 mm

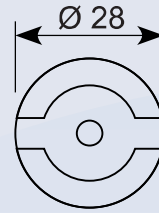

18.0261020



**Kabinetlås - lang**  
**Forkromet alloy**

Compartment lock - long  
Chromium-plated

Mont. hul: Ø22 mm  
Pladetykkelse: max  
8,5 mm  
Udv. Ø28 mm

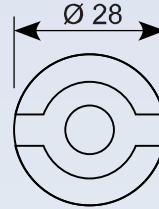

16.382



**Kabinetlås med rund front**  
**Sortlakeret til 8 mm firkantnøgle**  
**Nøgle: 16.382N**

Square-drive lock  
Black, with 8 mm square plug  
Key: 16.382N

A: 26 mm  
B: 27 mm  
C: 6 mm  
D: 12 mm  
D1: 19 mm  
E: 37 mm  
F: 15 mm  
G: 8 mm

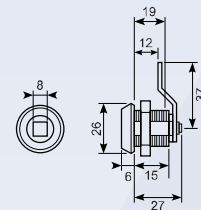

16.390



**Kabinetlås - kort**  
**Forkromet alloy til 8 mm firkantnøgle**

Compartment lock - short  
Chromium-plated, for 8 mm square key

A: Ø28 mm  
B: 28 mm  
C: 45 mm  
D: 18 mm  
E: 8 mm

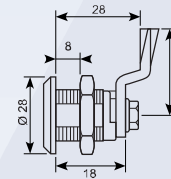

16.395



**Kabinetlås - lang**  
**Forkromet alloy til 8 mm firkantnøgle**

Compartment lock - long  
Chromium-plated, for 8 mm square key

A: Ø30 mm  
B: 30 mm  
C: 25 mm  
D: 28 mm  
E: 20 mm

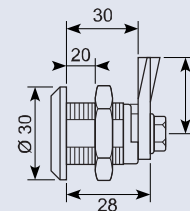

16.398



**Kabinetlås - lang**  
**Forkromet alloy til 8 mm firkantnøgle**

Compartment lock - long  
Chromium-plated, for 8 mm square key

A: Ø30 mm  
B: 40 mm  
C: 45 mm  
D: 40 mm  
E: 20 mm

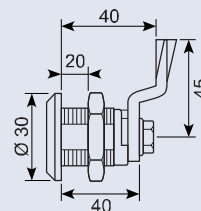

16.410



**Kabinetlås 7 mm firkant, flad tunge**  
**Effektiv 45.4 mm M22 x 1.5 mm forkromet**

Spanner lock, square 7 mm  
Chrome-plated

A: 27,7 mm  
B: 27 mm  
C: 4,5 mm  
D: 22 mm  
E: M22 x 1,5 mm

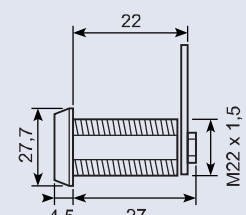

● Godt køb / best buy

### 16.411



**Kabinetlås 8 mm firkant, flad tunge**  
effektiv 45,4 mm M22 x 1,5 mm forkromet

Spanner lock, square 8 mm, chrome-plated

A: 27,7 mm  
B: 26,2 mm  
C: 5,5 mm  
D: 21,5 mm  
E: M20 x 1,5 mm

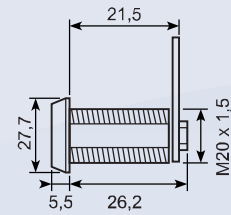

### 16.381



**Kabinetlås med rund front**  
**Sortlakeret til trekantnøgle**  
Nøgle: 16.381N

Tri-lock, all-black  
with triangular plug  
Key: 16.381N

A: 26 mm  
B: 27 mm  
C: 6 mm  
D: 12 mm  
D1: 19 mm  
E: 37 mm  
F: 15 mm  
G: 8 mm

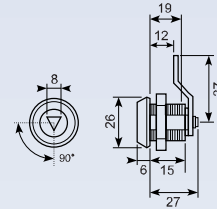

### 16.412



**Kabinetlås 8 mm trekant flad tunge**  
effektiv 45,4 mm M22 x 1,5 mm forkromet

Spanner lock, triangle 8 mm chrome-plated

A: 27,7 mm  
B: 26,8 mm  
C: 5,5 mm  
D: 21,5 mm  
E: M20 x 1,5 mm

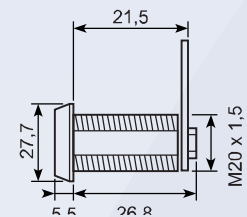

### 16.413



**Kabinetlås 9mm trekant, flad tunge**  
effektiv 45,4 mm M22 x 1,5 mm forkromet

Spanner lock, triangle 9 mm, chrome-plated

A: 27,7 mm  
B: 26,8 mm  
C: 5,5 mm  
D: 21,5 mm  
E: M20 x 1,5 mm

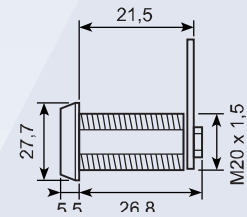

### 50.9785-1



**Kabinetlås 8mm trekant**

Cabin spanner lock

8 mm trekant  
ø 28 mm - 42 mm  
8 mm plade

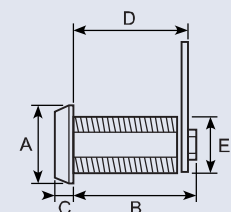

### 16.350



**Stovhætte til handskerumslås**  
**Blød PVC**

Moulded watershield  
Soft PVC

Montagehul: Ø19  
mm  
Låg indv.: Ø19 mm

### 17.621



**Nøgleskilt med hvælvet klap**  
**Alloy/chrom. Fjederbelastet klap.**

Escutcheon cover  
2-hole, chrome

A: 30 mm  
B: 8 mm  
C: 20 mm  
D: 11,5 mm  
Indv. hul: Ø12 mm  
Udv.: Ø30 mm

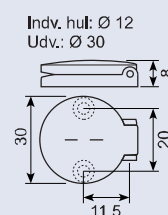

Godt køb / best buy

17.622



**Nøgleskilt med plan klap**  
Alloy/chrom. - klik for åben pos.

Escutcheon cover  
chrome-plated

A: 30 mm  
B: 8 mm  
C: 20 mm  
D: 11,5 mm  
Indv. hul: Ø12 mm  
Udv.: Ø30 mm

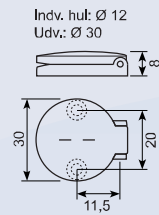

17.62583

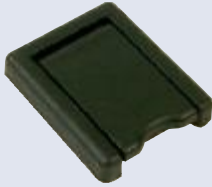

**Nøgleskilt - med stor klap**  
Sort kunststof

Door lock guard  
black synthetic material

Indv. hul: Ø16 mm  
H: 41 mm  
B: 51 mm

16.367



**Låsepal - plan med hage**  
El galvaniseret jern.  
Stjernehul til 8 mm firkant

Radius: 30 mm  
Hooked latch, single thickness  
Zinc-plated

A: 36 mm  
B: 30 mm

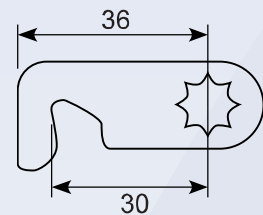

16.369



**Låsepal - plan med bøjede hjørner**  
El-galvaniseret jern  
Firkant hul til 8 mm

Cam latch bar, flat  
Zinc-plated

Radius: 48 mm

16.370



**Låsepal - plan, afrundet**  
El galvaniseret jern  
Stjernehul til 8 mm firkant

Latch bar, straight  
Zinc-plated, radius = 51 mm  
Eight-sided hole to accept  
8 mm square drive

A: 51 mm

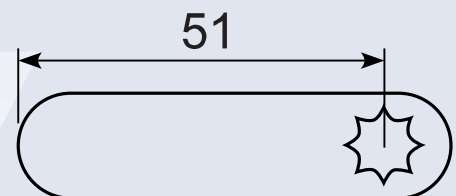

16.371



**Låsepal - plan, afrundet**  
El galvaniseret jern  
Stjernehul til 8 mm firkant

Latch bar, straight  
Zinc-plated, radius = 23 mm  
Eight-sided hole to accept  
8 mm square drive

Radius: 23 mm

## System- og nybygningsnøgler / Mandrel keys

17.5507



**Nybygningsnøgle, alloy.**

Mandrel key  
Alloy, square hole

Længde: 85 mm  
Tap: 6-9 mm

17.508



**Nybygningsnøgle, Alloy.**

Mandrel key  
Nickel-plated, malleable casting

Længde : 95 mm  
Tap: 7-10 mm

17.512



**Nybygningsnøgle. Alloy.**

Mandrel key.  
Nickel-plated, malleable casting.

Længde: 130 mm  
Tap: 7-10 mm

17.515



**Nybygningsnøgle, alloy.**

Mandrel key  
Nickel-plated malleable casting

Længde: 160 mm  
Tap: 7-10 mm

18.0956170



**Firkantnøgle**

Key for square drive

Længde 59 mm

16.410-1



**78 mm nøgle for 7 mm firkant forkromet**

Spanner lock key, square 7 mm  
Chrome-plated

 Godt køb / best buy

### 16.411-1



78 mm nøgle for 8 mm firkant forkromet

Spanner lock key, square 8 mm, chrome-plated

### 16.412-1



78 mm nøgle for 8 mm trekant, forkromet

Key blank for 820-08CP, chrome plated

### 16.413-1



78 mm nøgle for 9 mm trekant  
Sort overflade

Spanner lock key, triangle 9 mm, black finish

### 18.0956610



Nøgle lavvolt 8 mm. Alloy

Key low voltage 8 mm  
Alloy

### 18.0956620



Nøgle - dobbelttap  
Alloy - ubehandlet

Key 8 mm  
Alloy

### 16.381N



Nøgle med trekant til lås 16.381  
Alloy/ chrom med 2 nøgler.

A: 62 mm

Key for tri-lock - steel  
with 2 keys

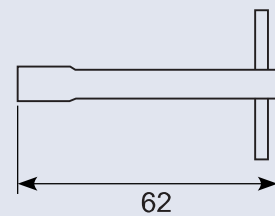

### 16.382N



Nøgle med firkant til lås 16.382

A: 62 mm

Key for square-drive lock 16.382

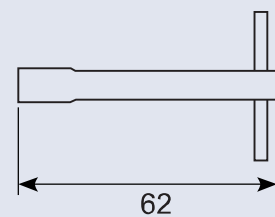

Godt køb / best buy

18.095646



**Universalnøgle til kabinetslåse**  
Alloy - til trekant og firkant, stor og lille  
samt dobbelttap.

Key pin 3 mm + 5 mm  
for square 6 mm + 3 mm and triangle 8 mm

16.414-1



**55 x 24 mm nøgle for 3 mm bits**  
Sort overflade

Spanner lock key, double bits 3 mm  
Black finish

16.415-1



**55 x 25 mm nøgle for 5 mm bits**  
Sort overflade

Spanner lock key, double bit 5 mm black  
painted

 Godt køb / best buy



## Kilelåse og fjederigler / Antiluce fasteners and spring bolts

### 18.182A



**Kilelås/vippelås - stor**  
**Galvaniseret jern med tap Ø12 mm.**

Antiluce fastener - large  
Zinc-plated, with Ø12 mm shaft

A: 19 mm  
B: 6,4 mm  
C: M 12  
D: 12 mm

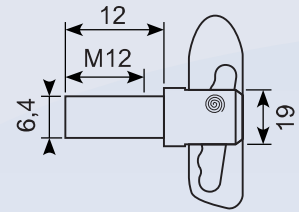

### 18.182X



**Kilelås/vippelås - stor**  
**Galvaniseret jern med M12 gevind.**

Antiluce fastener - large  
Zinc-plated, with Ø12 mm thread

A: 19 mm  
B: 4,8 mm  
C: 12 mm  
D: 24 mm  
E: M12  
F: 18 mm

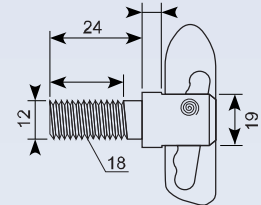

### 18.183



**Kilelås/vippelås - lille**  
**Galvaniseret jern - 5/16 gevind med**  
**møtrik og skive.**

Antiluce fastener - small  
Zinc-plated - 5/16, complete with nut and 2 washers

A: 13 mm  
B: 6,4 mm  
C: 8 mm  
D: 21 mm  
E: M 8  
F: 18 mm

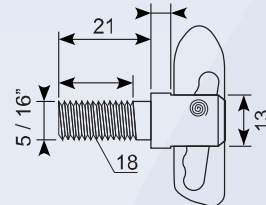

### 18.183X



**Kilelås/vippelås - lille**  
**Galvaniseret jern med tap Ø8 mm.**

Antiluce fastener - small  
Zinc-plated, with Ø8 mm shaft

A: 13 mm  
B: 6,4 mm  
C: 8 mm  
D: 9,5 mm

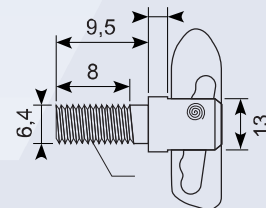

### 18.185J



**Rigellås med fjederbelastning**  
**Jern med jern-kerne og alloy håndtag.**

Spring bolt, springloaded  
Iron with iron core and alloy handle

A: 57 mm  
B: 45 mm  
C: 41 mm  
D: 10 mm  
E: 14 mm  
F: Ø20 mm

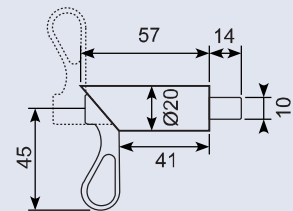

### 18.185S



**Rigellås med fjederbelastning**  
**Jern med rustfri kerne og alloy håndtag.**

Spring bolt, springloaded  
Iron with stainless core and alloy handle

A: 57 mm  
B: 45 mm  
C: 41 mm  
D: 10 mm  
E: 14 mm  
F: Ø20 mm

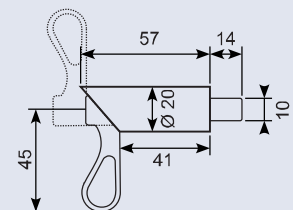

### 18.195



**Fjederriegel bolt Ø14 mm med 1/2"**  
**gevind, 20 mm lang**

Spring bolt Ø14 mm with 1/2" thread, depth  
20 mm

● Godt køb / best buy

### 18.186J



**Fjederrigel - 12 mm**  
**Galvaniseret jern, med stopbolte.**

Spring bolt with spring - 12 mm  
Zinc-plated, with stop bolts

A: 160 mm  
B: 20 mm  
C: 17,5 mm  
D: 40 mm  
E: 28 mm  
F: 50 mm  
G: 12 mm  
H: 30 mm

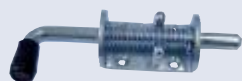
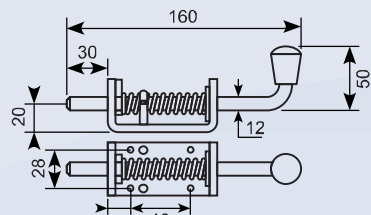

### 18.187

**Fjederrigel - 13 mm**  
**Galvaniseret jern**

Spring bolt - 13 mm  
Zinc-plated

A: 165 mm  
B: 17 mm  
C: 16 mm  
D: 41 mm  
E: 28 mm  
F: 46,3 mm  
G: 12,5 mm  
H: 30 mm

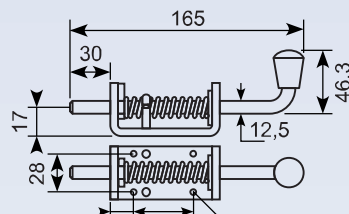

### 18.188J



**Skudrigel**  
**Galvaniseret tern**

Spring loaded bolt

Dorn: Ø13 mm  
Plade: 40x85 mm  
Dorn: 150x50 mm



### 18.189J



**Skudrigel**  
**Galvaniseret tern.**

Spring loaded bolt

Dorn: Ø14 mm  
Plade: 40x85 mm  
Dorn: 190x85 mm



### 18.196A



**Modhold til 18.196-150, 18.196-170,  
18.196-190 og 18.196-330. Ubehandlet til  
svejsning. Sort.**

Catcher for spring bolt, black. Natural finish  
for welding.



### Fjederrigel



Vare nr.	A	B
	mm	mm
18.196-150	150	Ø12
18.196-170	170	Ø12
18.196-190	190	Ø12
18.196-330	330	Ø12

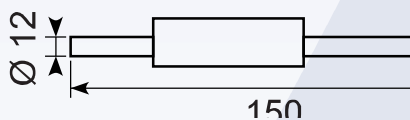

● Godt køb / best buy

## Snaplås og modhold / Fasteners and catch plates

### 18.70ZN



**Snaplås - galvaniseret**  
**Lille model. 11 mm**

Rigid fastener, light duty - zinc-plated. 11 mm

### 18.10589ZN



**Protex snaplås - galvaniseret jern**  
**Forberedt for sikring med split.**  
**Brudstyrke: 38 kg.**  
**Passer til modhold 18.01589ZN. 11 mm.**

Rigid fastener, light duty - zinc-plated  
Prepared for split pin  
Ultimate strength: 38 kg  
Fits catchplate 18.01589ZN. 11 mm.

### 18.125



**Excenterlukker m. bøjle for hængelås**  
**Galvaniseret**  
**Justérbar 70 - 82 mm**



Side board latch

### 18.127



**Rustfri excenterlukker m. bøjle**  
**(Modhold evt. 18.129). 11 mm.**

Længde: 94 mm



Big latch with wire hook, no catcher included  
no name. 11 mm.

### 18.128



**Rustfri excenterlukker m. hul til lås**  
**(Modhold evt. 18.129). 11 mm.**

Længde: 64 mm



Small latch, hole for paddlelock  
Stainless steel

### 18.569A



**Lukkebeslag u. hage 29.569ZN forzinket**

Locking fastenings without hook 29.569ZN,  
zinc-plated

A: 57,6 mm  
B: 31,7 mm  
C: 20,6 mm  
D: 15,1 mm  
E: 13,9 mm  
F: 29,1 mm  
G: 12,7 mm  
H: 11,9 mm  
I: 19,8 mm  
J: 14,3 mm  
K: Ø7,1 mm  
L: Ø4,2 mm

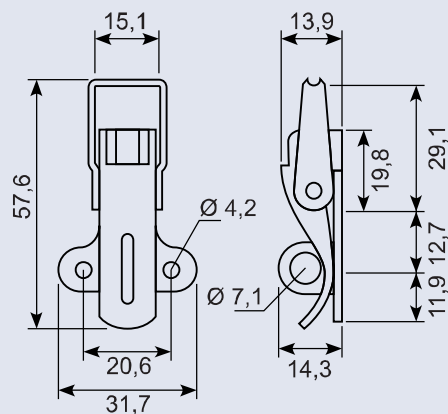

 Godt køb / best buy

### 18.291700ZN



**Protex snaplås - galvaniseret jern**  
**Forberedt for hængelås.**  
**Brudstyrke: 165 kg.**  
**Passer til modhold**  
**18.01535ZN/18.03535ZN. 14 mm.**

Rigid fastener, light duty - zinc-plated  
 Prepared for padlock  
 Ultimate strength: 165 kg  
 Fits catchplate 18.01535ZN/18.03535ZN.  
 14 mm.

A: 64,2 mm  
 B: 15,1 mm  
 C: 14,2 mm  
 D: 28,5 mm  
 E: 19,3 mm  
 F: 28 mm  
 G: 5,3 mm  
 H: Ø4,2 mm  
 I: Ø7,1 mm

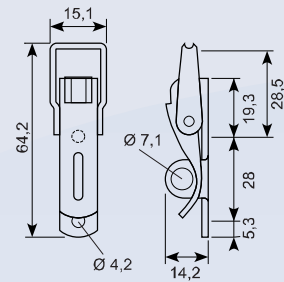

### 18.291700SS



**Protex snaplås - rustfri**  
**Forberedt for hængelås.**  
**Brudstyrke: 165 kg.**  
**Passer til modhold**  
**18.01535/18.03535. 14 mm.**

Rigid fastener, light duty - Stainless steel  
 Prepared for padlock  
 Ultimate strength: 165 kg  
 Fits catchplate 18.01535/18.03535. 14 mm.

A: 64,2 mm  
 B: 15,1 mm  
 C: 14,2 mm  
 D: 28,5 mm  
 E: 19,3 mm  
 F: 28 mm  
 G: 5,3 mm  
 H: Ø4,2 mm  
 I: Ø7,1 mm

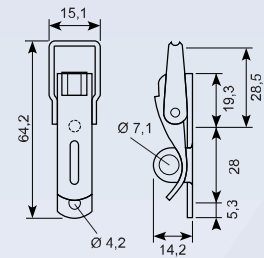

### 18.27633ZN



**Protex snaplås - galvaniseret. 16 mm.**

Rigid fastener - zinc-plated. 16 mm.

A: 88 mm  
 B: 22,3 mm  
 C: 17,6 mm  
 D: 46,2 mm  
 E: 14 mm  
 F: 2,6 mm  
 G: 23,4 mm  
 H: 13,3 mm  
 I: 15,7 mm  
 J: 23,6 mm  
 K: Ø4,1 mm

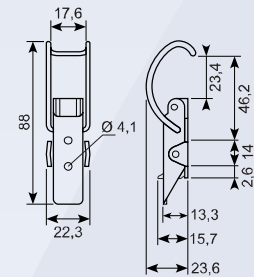

### 18.27645ZN



**Protex lukker uden hage forzinket**

Protex fastener without hook, zinc-plated

A: 88 mm  
 B: 22,3 mm  
 C: 17,6 mm  
 D: 46,2 mm  
 E: 14 mm  
 F: 2,6 mm  
 G: 23,4 mm  
 H: 13,3 mm  
 I: 15,7 mm  
 J: 23,6 mm  
 K: Ø4,1 mm

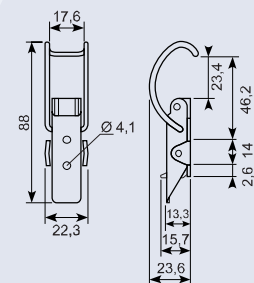

### 18.27633SS



**Protex snaplås - rustfri. 16 mm.**

Rigid fastener - stainless steel. 16 mm.

A: 88 mm  
 B: 22,3 mm  
 C: 17,6 mm  
 D: 46,2 mm  
 E: 14 mm  
 F: 2,6 mm  
 G: 23,4 mm  
 H: 13,3 mm  
 I: 15,7 mm  
 J: 23,6 mm  
 K: Ø4,1 mm

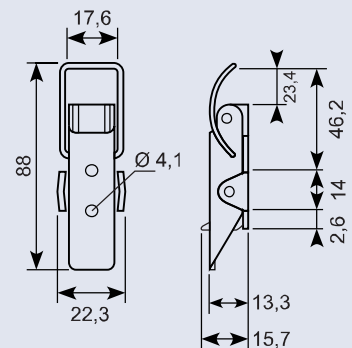

### 18.611750ZN



**Protex snaplås - galvaniseret med lås**  
**Justerbar - forberedt for sikring**  
**med split.**  
**Brudstyrke: 450 kg.**  
**Passer til modhold 18.03655ZN. 16 mm.**

Adjustable fasteners, locking  
Zincplated, pin seal  
Ultimate strength: 450 kg  
Fits catchplate 18.03655ZN. 16 mm.

A: 88-98 mm  
B: 19 mm  
C: 17,1 mm  
D: Ø6 mm  
E: 26 mm  
F: 15 mm  
G: 25,4 mm  
H: 11,6 mm  
I: 17 mm  
J: 20,7 mm  
K: 4,2 mm

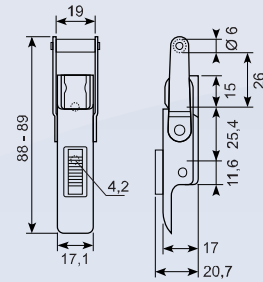

### 18.611750SS



**Protex snaplås - rustfri jern med lås**  
**Justerbar - forberedt for sikring**  
**med split.**  
**Brudstyrke : 450 kg. 16 mm.**

Adjustable fasteners, medium duty, locking -  
stainless steel pin seal  
Ultimate strength: 450 kg  
Fits catchplate 18.03655SS. 16 mm.

A: 88-98 mm  
B: 19 mm  
C: 17,1 mm  
D: Ø6 mm  
E: 26 mm  
F: 15 mm  
G: 25,4 mm  
H: 11,6 mm  
I: 17 mm  
J: 20,7 mm  
K: Ø4,2 mm

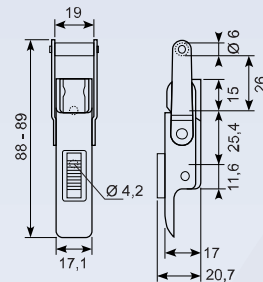

### 18.1090132ZN



**Justerbar snaplås - galvaniseret. 16 mm.**

Adjustable fasteners - zincplated. 16 mm.

A: 66-75 mm  
B: 17 mm  
C: 53 mm  
D: 14,5 mm  
E: 10,5 mm  
F: 2 mm  
G: Ø4,3 mm

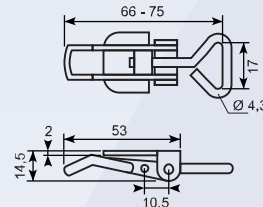

### 18.15531SS

**Protex lukker u/hage, rustfri**

Protex fasteners without hook, SS

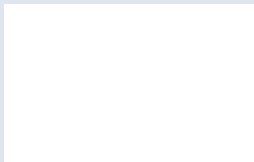

### 18.282150ZN

**Protex snaplås - galvaniseret jern**  
**Til låg eller faldede kanter.**  
**Brudstyrke : 75 kg.**  
**Passer til modhold : 18.042150ZN**

Spring Claw Fastener, light duty - zinc-plated  
For lids or flanged edges.  
Ultimate strength: 75 kg  
Fits catchplate 18.042150ZN

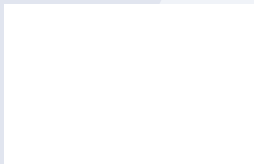

### 18.18613ZN



**Protex snaplås - galvaniseret jern**  
**Forberedt for sikring med split.**  
**Brudstyrke : 195 kg.**  
**Passer til modhold**  
**18.02613ZN/18.03613ZN. 16 mm.**

Rigid fasteners, light duty - zincplated  
Prepared for split pin  
Ultimate strength: 195 kg  
Fits catchplate 18.02613ZN/18.03613ZN.  
16 mm.

## 18.18613SS

### Protex lukker u/hage rustfri

Protex fastener without hook SS

## 18.108SS

### Rustfri, justerbar snaplås. 16 mm.

Stainless rigid fastener. 16 mm.



A: 66-75 mm  
B: 17 mm  
C: 53 mm  
D: 14,5 mm  
E: 10,5 mm  
F: 2 mm  
G: Ø4,3 mm

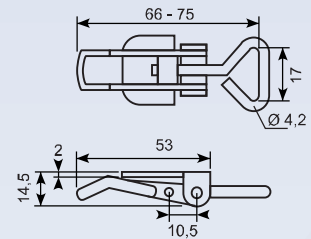

## 18.2005000SS

### Protex justerbar lukker uden hage, rustfri Protex adjustable fastener without hook stainless



## 18.20505SS

### Protex snaplås - rustfri. 16 mm.

Rigid fastener - stainless steel. 16 mm.



A: 50,6 mm  
B: 23 mm  
C: 18,3 mm  
D: 29,9 mm  
E: 10 mm  
F: 11,1 mm  
G: 13,5 mm

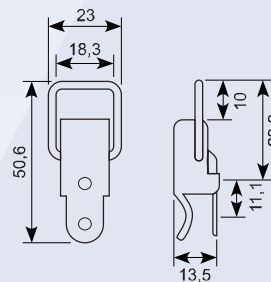

## 18.165

### Snaplås - aflåselig Sort-lakeret jern. 22 mm.

Over-centre toggle fastener powder coated. 22 mm.



A: 170 mm  
B: 25,4 mm  
C: 129 mm  
D: 5,5 mm  
E: 27 mm  
F: Ø11,5 mm  
G: 55 mm

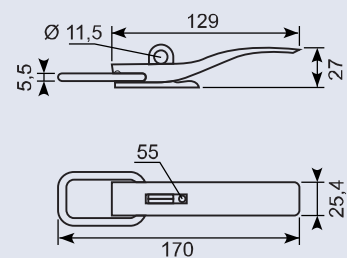

## 18.506

### Protex snaplås - galvaniseret jern Til låg eller faldede kanter. Brudstyrke: 75 kg. Passer til modhold 18.042150. 22-24 mm.

Rigid fastener, medium duty - zincplated  
For lids or flanged edges.  
Ultimate strength: 75 kg  
Fits catchplate 18.042150. 22-24 mm.



A: 116 mm  
B: 24,6 mm  
C: 23,8 mm  
D: 20,6 mm  
E: 37,4 mm  
F: 34,1 mm  
G: 7,9 mm  
H: 33,3 mm  
I: 26,2 mm  
J: 18,4 mm  
K: Ø5,1 mm  
L: Ø3,6 mm  
M: Ø7,5 mm

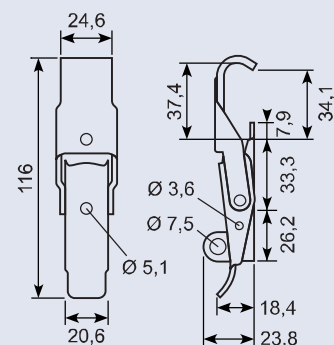

### 18.271837SS



**Protex snaplås - rustfri stål med lås**  
**Med trækfjeder, forberedt for sikring**  
**med split.**  
**Brudstyrke: 66 kg.**  
**Passer til modhold 18.01502/18.02502. 24**  
**mm.**

Rigid fastener, medium duty - locking.  
 With tension spring, prepared for split pin.  
 Ultimate strength: 66 kg  
 Fits catch plate 18.01502/18.02502. 24 mm.

A: 79,4 mm  
 B: 23,9 mm  
 C: 22,3 mm  
 D: 19,9 mm  
 E: 42,6 mm  
 F: 14 mm  
 G: 6,2 mm  
 H: 13,3 mm  
 I: 16,7 mm  
 J: 21,1 mm  
 K: Ø4,1 mm  
 L: Ø3,2 mm

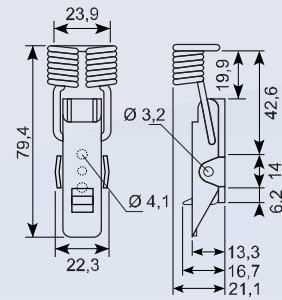

### 18.30570ZN



**Protex snaplås - galvaniseret**  
**Forberedt for sikring med split og**  
**hængelås.**  
**Brudstyrke : 450 kg.**  
**Passer til modhold**  
**18.01502/18.02502. 24 mm.**

Rigid fastener, medium duty  
 - zinc plated  
 Prepared for padlock and split pin  
 Ultimate strength: 450 kg  
 Fits catchplate 18.01502/18.02502. 24 mm.

### 18.30570SS



**Protex snaplås - rustfri**  
**Forberedt for sikring med split og**  
**hængelås.**  
**Brudstyrke: 450 kg.**  
**Passer til modhold**  
**18.01502/18.02502. 24 mm.**

Rigid fastener, medium duty  
 - Stainless steel  
 Prepared for padlock and split pin  
 Ultimate strength: 450 kg  
 Fits catchplate 18.01502/18.02502. 24 mm

### 18.3510598SS

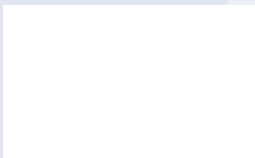

**Protex snaplås - rustfri stål, uden lås**  
**Forberedt for sikring med split.**  
**Brudstyrke : 450 kg.**  
**Passer til modhold**  
**18.01502SS/18.02502SS. 22 mm.**

Rigid fastener, medium duty  
 - stainless steel  
 Pin seal.  
 Ultimate strength: 450 kg  
 Fits catchplate 18.01502SS/18.02502SS.  
 22 mm.

A: 167,2 mm  
 B: 50,8 mm  
 C: 129,8 mm  
 D: 38,1 mm  
 E: 21,8 mm  
 F: 78 mm  
 G: 40,6 mm  
 H: 40 mm  
 I: 7,9 mm  
 J: 17,7 mm  
 K: 21,8 mm  
 L: Ø5,1 mm

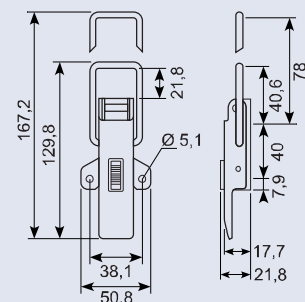

### 18.351163



**Protex snaplås - galvaniseret**  
**Med trækfjeder, forberedt for sikring**  
**med split.**  
**Brudstyrke: 66 kg.**  
**Passer til modhold**  
**18.01502ZN/18.02502ZN. 26 mm.**

Spring fastener, medium duty - zincplated  
 With tension spring, pin seal  
 Ultimate strength: 66 kg  
 Fits catchplate 18.01502ZN/18.02502ZN.  
 26 mm.

A: 130 mm  
 B: 50,8 mm  
 C: 38,1 mm  
 D: 26,5 mm  
 E: 4,8 mm  
 F: 44,2 mm  
 G: 40 mm  
 H: 7,9 mm  
 I: 17,9 mm  
 J: 21,9 mm  
 K: 18,8 mm  
 L: Ø5,1 mm

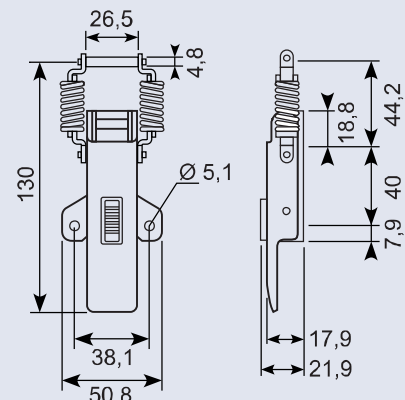

### 18.361058SS



**Protex snaplås - rustfri stål med lås**  
**Forberedt for sikring med split.**  
**Brudstyrke: 450 kg.**  
**Passer til modhold**  
**18.01502SS/18.02502SS. 24 mm.**

Rigid fastener, medium duty locking  
 Pin seal  
 Ultimate strength: 450 kg  
 Fits catchplate 18.01502SS/18.02502SS.  
 24mm.

A: 167,2 mm  
 B: 50,8 mm  
 C: 129,8 mm  
 D: 38,1 mm  
 E: 21,8 mm  
 F: 78 mm  
 G: 40,6 mm  
 H: 40 mm  
 I: 1,9 mm  
 J: 17,7 mm  
 K: 21,8 mm  
 L: Ø5,1 mm

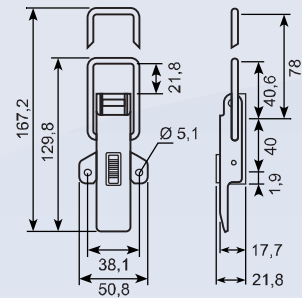

### 18.361163ZN



**Protex snaplås - Galvaniseret**  
**Med trækfjeder, forberedt for sikring**  
**med split.**  
**Brudstyrke: 66 kg.**  
**Passer til modhold**  
**18.01502ZN/18.02502ZN. 24 mm.**

Rigid fastener, medium duty - locking,  
 zincplated  
 With tension spring, pin seal  
 Ultimate strength: 66 kg  
 Fits catchplate 18.01502ZN/18.02502ZN.  
 24 mm.

A: 130 mm  
 B: 50,8 mm  
 C: 38,1 mm  
 D: 26,5 mm  
 E: 4,8 mm  
 F: 44,2 mm  
 G: 40 mm  
 H: 7,9 mm  
 I: 17,9 mm  
 J: 21,9 mm  
 K: 18,8 mm  
 L: Ø5,1 mm

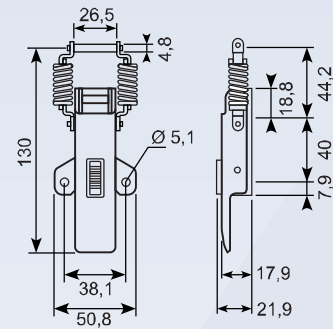

### 18.361163SS

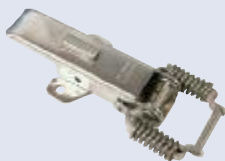

**Protex snaplås - rustfri stål med lås**  
**Med trækfjeder, forberedt for sikring**  
**med split.**  
**Brudstyrke: 66 kg.**  
**Passer til modhold**  
**18.01502SS/18.02502SS. 24 mm.**

Rigid fastener, medium duty - locking,  
 stainless steel  
 With tension spring, pin seal  
 Ultimate strength: 66 kg  
 Fits catchplate 18.01502SS/18.02502SS.  
 24 mm.

A: 130 mm  
 B: 50,8 mm  
 C: 38,1 mm  
 D: 26,5 mm  
 E: 4,8 mm  
 F: 44,2 mm  
 G: 40 mm  
 H: 7,9 mm  
 I: 17,9 mm  
 J: 21,9 mm  
 K: 18,8 mm  
 L: Ø5,1 mm

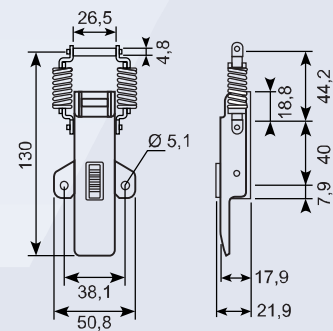

### 18.371260ZN



**Protex snaplås - galvaniseret, aflåselig**  
**Leveres med 2 nøgler**  
**Brudstyrke : 494 kg**  
**Passer til modhold**  
**18.01502ZN/18.02502ZN. 24 mm.**

Rigid fastener, medium duty, locking  
 zinc-plated with two keys  
 Ultimate strength: 494 kg  
 Fits catchplate 18.01502ZN/18.02502ZN.  
 24 mm.

A: 13,3 mm  
 B: 28,6 mm  
 C: 22,8 mm  
 D: 23 mm  
 E: 17,3 mm  
 F: 35,5 mm  
 G: 22 mm  
 H: 23,5 mm  
 I: Ø5,1 mm

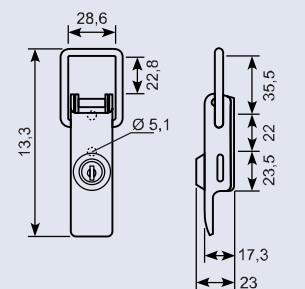

### 18.391260ZN



**Protex snaplås - galvaniseret med**  
**kærskrue-lås**  
**Forberedt for sikring med split**  
**Brudstyrke: 450 kg.**  
**Passer til modhold**  
**18.01502ZN/18.02502ZN. 24 mm.**

Rigid fastener, medium duty, locking  
 Zinc-plated  
 Prepared for split pin  
 Ultimate strength: 450 kg  
 Fits catchplate 18.01502ZN/18.02502ZN.  
 24 mm.

A: 113,3 mm  
 B: 28,6 mm  
 C: 22,8 mm  
 D: 38,1 mm  
 E: 25,1 mm  
 F: 17,3 mm  
 G: 21,0 mm  
 H: 35,5 mm  
 I: 22 mm  
 J: 23,5 mm  
 K: Ø5,1 mm  
 L: Ø10 mm

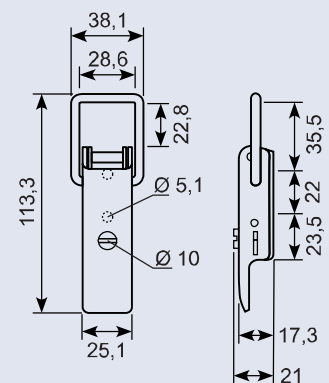



### 18.701273ZN



**Protex snaplås - galvaniseret jern**  
**Justerbar - forberedt for sikring med split.**  
**Brudstyrke: 660 kg.**  
**Passer til modhold 18.06625ZN/18.011273CZN. 24 mm.**

Adjustable fasteners, medium duty  
Zinc-plated, wide based  
Pin seal.  
Ultimate strength: 660 kg  
Fits catchplate 18.06625ZN/18.011273CZN.  
24 mm.

A: 132,7-142,7 mm  
B: 50,8 mm  
C: 38,1 mm  
D: 27 mm  
E: Ø6,4 mm  
F: 23 mm  
G: 21,6 mm  
H: 38,3-48,3 mm  
I: 17,5 mm  
J: 12,7 mm  
K: 28,6 mm  
L: 7,9 mm  
M: Ø5,1 mm

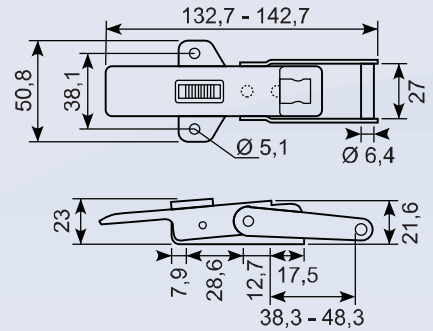

### 18.70653CZN

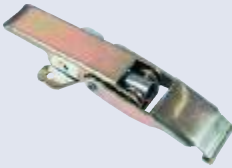

**Protex snaplås - galvaniseret jern**  
**Til låg eller faldede kanter.**  
**Forberedt for sikring med split.**  
**Brudstyrke: 454 kg. 22-24 mm.**

Adjustable fasteners, medium duty  
Zincplated  
For lids or flanged edges.  
Pin seal  
Ultimate strength: 454 kg. 22-24 mm.

A: 148,8 - 158,8 mm  
B: 50,8 mm  
C: 38,1 mm  
D: 25,4 mm  
E: 22,8 mm  
F: 21,6 mm  
G: 60,9 - 70,9 mm  
H: 57,3 - 67,3 mm  
I: 17,4 mm  
J: 12,7 mm  
K: 28,6 mm  
L: 7,9 mm  
M: Ø5,1 mm

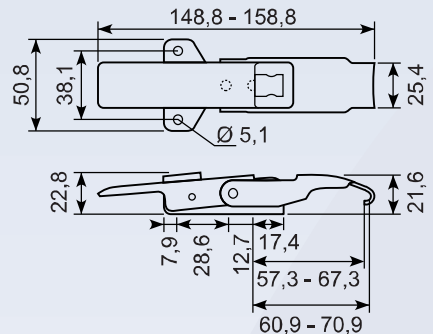

### 18.70653SS



**Protex snaplås - rustfri**  
**Til låg eller faldede kanter.**  
**Forberedt for sikring med split.**  
**Brudstyrke : 454 kg. 22 mm.**

Adjustable fasteners, medium duty -  
stainless steel  
For lids or flanged edges.  
Pin seal  
Ultimate strength: 454 kg. 22 mm.

A: 148,8-158,8 mm  
B: 50,8 mm  
C: 38,1 mm  
D: 25,4 mm  
E: 22,8 mm  
F: 21,6 mm  
G: 60,9-70,9 mm  
H: 57,3-67,3 mm  
I: 17,4 mm  
J: 12,7 mm  
K: 28,6 mm  
L: 7,9 mm  
M: Ø5,1 mm

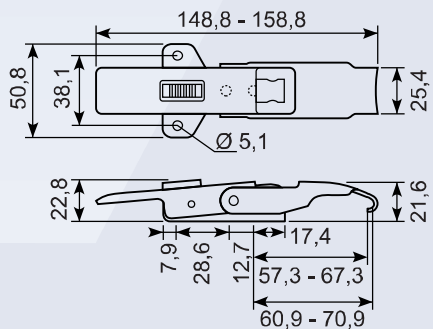

### 18.711273ZN



**Protex snaplås. Galvaniseret med lås. 24 mm.**

Adjustable fasteners, zinc-plated,  
safety-catch version. 24 mm.

A: 132,7-142,7 mm  
B: 50,8 mm  
C: 38,1 mm  
D: 27 mm  
E: Ø6,4 mm  
F: 23 mm  
G: 21,6 mm  
H: 38,3-48,3 mm  
I: 17,5 mm  
J: 12,7 mm  
K: 28,6 mm  
L: 7,9 mm  
M: Ø5,1 mm

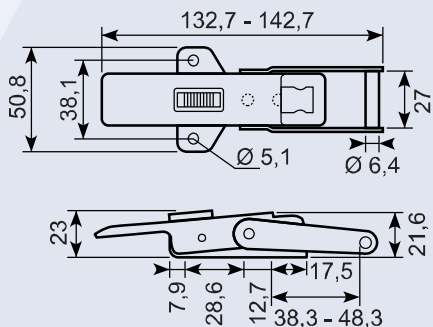

### 18.71653CZN



**Protex snaplås - galvaniseret med lås**  
**Til låg eller faldede kanter.**  
**Forberedt for sikring med split.**  
**Brudstyrke 454 kg. 22-24 mm.**

Adjustable fasteners, medium  
duty - zincplated  
Safety catch version, pin seal  
Ultimate strength: 454 kg. 22-24 mm.

A: 148,8 - 158,8 mm  
B: 50,8 mm  
C: 38,1 mm  
D: 25,4 mm  
E: 22,8 mm  
F: 21,6 mm  
G: 60,9 - 70,9 mm  
H: 57,3 - 67,3 mm  
I: 17,4 mm  
J: 12,7 mm  
K: 28,6 mm  
L: 7,9 mm  
M: Ø5,1 mm

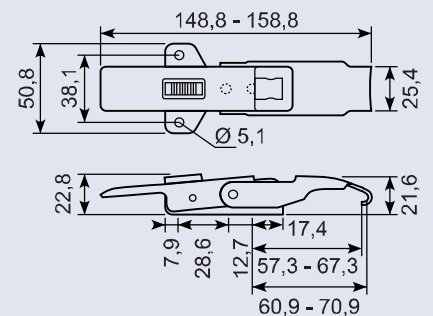

## 18.711273CZN



### Protex lukker med pal uden hage. Galvaniseret.

Protex fasteners with pawl without hook,  
zinc-plated

## 18.71653SS



### Protex snaplås - rustfri Til låg med falsede kanter Justerbar lås Brudstyrke 420 kg. 24 mm.

Adjustable fasteners, medium duty  
Stainless steel  
Safety catch version.  
Ultimate strength 420 kg. 24 mm.

A: 148,8 - 158,8 mm  
B: 50,8 mm  
C: 38,1 mm  
D: 25,4 mm  
E: 22,8 mm  
F: 21,6 mm  
G: 60,9 - 70,9 mm  
H: 57,3 - 67,3 mm  
I: 17,4 mm  
J: 12,7 mm  
K: 28,6 mm  
L: 7,9 mm  
M: Ø5,1 mm

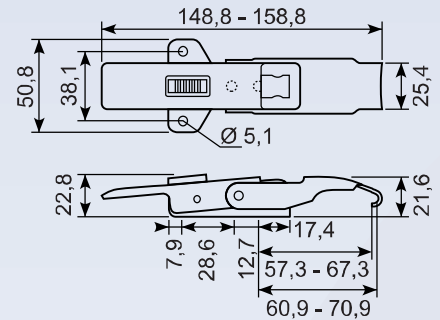

## 18.653R

### Protex lukker rustfri uden hage 70-653

Protex stainless fasteners without hook 70-653

## 18.109



### Snaplås med gummistrop Army-grøn lakeret jern

Stowage clamp with rubber  
tension strap  
Green primed steel

A: 150 mm  
B: 83 mm  
C: 40 mm  
D: 35 mm  
E: Ø5,3 mm

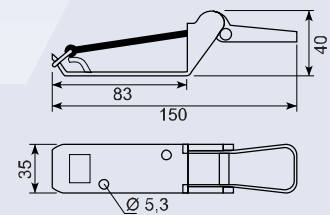

## 18.122



### Snaplås med vinklet modhold Galvaniseret jern, velegnet til låg og kasser. Leveres komplet.

Toggle fasteners with angular  
counterhold  
Zincplated, suited for covers and  
boxes

A: 100 mm  
B: 145 mm  
C: 32 mm

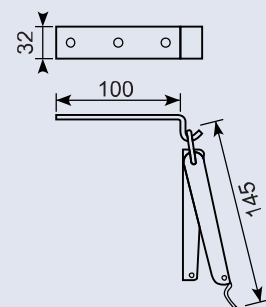

## 18.121



### Snaplås med vinklet modhold Galvaniseret jern, velegnet til låg og kasser. Leveres komplet.

Toggle fasteners with angular  
counterhold  
Zincplated, suited for covers and boxes

A: 85 mm  
B: 100 mm  
C: 16 mm

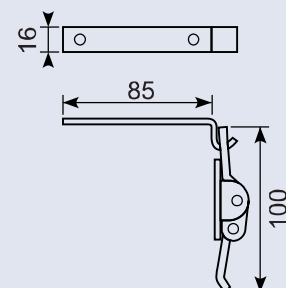

## 18.126



**Excenterlukker m. bøjle for hængelås**  
**Justérbar 155 - 170 mm**  
**incl. hjertekrog 44,5 x 21 mm**  
**Galvaniseret**



Side board latch with hook

## 18.505



**Protex snaplås - galvaniseret**  
**incl. hage nr. 18.01504**

Rigid fastener - zinc-plated  
 Complete incl. 18.01504

A: 50,6 mm  
 B: 23 mm  
 C: 18,3 mm  
 D: 29,9 mm  
 E: 11,1 mm  
 F: 10 mm  
 G: 13,5 mm  
 H: Ø3,3 mm

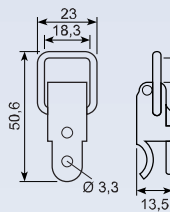

## 18.506R

**Protex lukker rustfri uden hage**

Protex fastener without hook, stainless

A: 116 mm  
 B: 20,6 mm  
 C: 37,4 mm  
 D: 34,1 mm  
 E: 7,9 mm  
 F: 33,3 mm  
 G: 26,2 mm  
 H: 18,4 mm  
 I: Ø3,6 mm  
 J: Ø5,1 mm

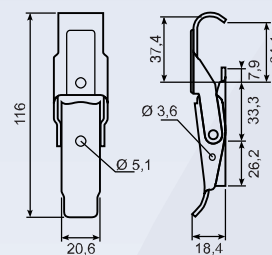

## 18.569

**Snaplås komplet med modhold**

Rigid fastener, light duty with catchplate



A: 64,2 mm  
 B: 15,1 mm  
 C: 14,2 mm  
 D: 28,5 mm  
 E: 19,3 mm  
 F: 28 mm  
 G: 5,3 mm  
 H: Ø4,2 mm  
 I: Ø7,1 mm

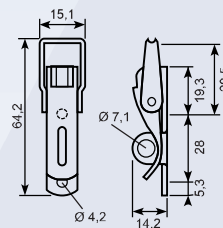

## 18.569SS

**Lukkebeslag uden hage rustfri.**

Locking fastenings without hook, stainless

## 18.6461010ZN

**Protex snaplås - el-galvaniseret stål**  
**Komplet med indbygningsplade.**  
**Brudstyrke: 325 kg.**  
**Holder i to retninger - kan foruden træk**  
**også presse panel eller låge mod f.eks.**  
**pakning. Forberedt for sikring med split**  
**eller hængelås.**

ProLatch® Catch Bolt - SS in recessed dish  
 Ultimate strength: 325 kg  
 Also forces a panel or door against a seal,  
 and holds firmly in two planes. Safety catch  
 is incorporated. Padlockable or pin seal  
 version.

A: 50,8 mm  
 B: 112 mm  
 C: 114,3 mm  
 D: 83,4 mm  
 E: 98 mm  
 F: 46 mm  
 G: 11 mm  
 H: 29 mm  
 I: 22 mm  
 J: 45 mm  
 K: 15,1 mm  
 L: 17,2 mm  
 M: Ø4,1 mm

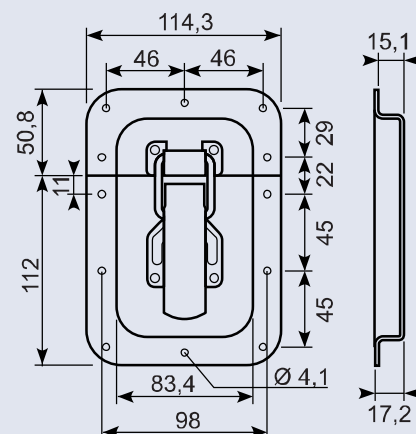

Godt køb / best buy

## 18.11679SS

Låsesplit til Protex snaplåse  
- rustfri stål

Split pin for Protex fasteners - SS



A: 70 mm  
B: 76 mm  
C: 19 mm  
D: 2,6 mm

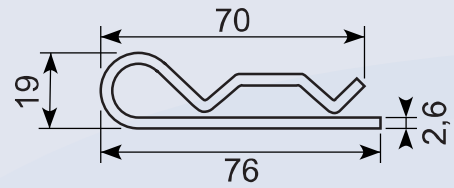

## Spændebånd

Vare nr.	Diameter mm
18.27HT070115SS	Ø70 - 115
18.27HT090135SS	Ø90 - 135
18.27HT130175SS	Ø130 - 175
18.27HT170215SS	Ø170 - 215
18.27HT210255SS	Ø210 - 255
18.27HT250295SS	Ø250 - 295
18.27HT290335SS	Ø290 - 335
18.27HT330375SS	Ø330 - 375



Protex spændebånd med  
snaplås - rustfri stål  
Brudstyrke 135 kg

Protex fastener, stainless steel Ultimate strength  
135 kg

## 18.01589ZN

Modhold - plan 11 mm  
galvaniseret jern

Catchplate - plane 11 mm  
zinc-plated



A: 30,2 mm  
B: 7,9 mm  
C: 3,2 mm  
D: 22,2 mm  
E: 11,1 mm  
F: 0,9 mm  
G: 6 mm

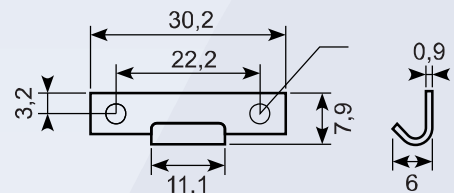

## 18.129



Rustfri modhold m. 2 huller. 11 mm.

Clips loose with 2 holes. 11 mm.



## 18.01535SS

Modhold - plan 11 mm  
rustfri stål

Catchplate - plane 11 mm  
stainless steel



A: 32,2 mm  
B: 17,1 mm  
C: 11,3 mm  
D: 21 mm  
E: 5,6 mm  
F: 2 mm  
G: Ø4,1 mm

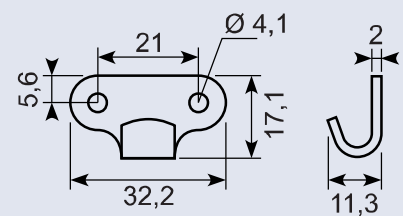

## 18.01535ZN

Modhold - plan 11 mm galvaniseret

Catchplate-plane 11 mm, zinc-plated



A: 32,2 mm  
B: 17,1 mm  
C: 11,3 mm  
D: 21 mm  
E: 5,6 mm  
F: 2 mm  
G: Ø4,1 mm

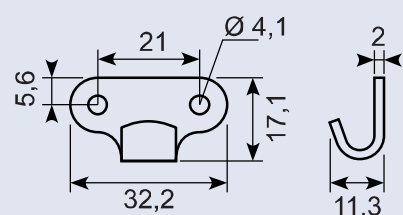

● Godt køb / best buy

## 18.01500SS

### Protex rustfri hage f/lukker 18.2005000S f/lukker 18.2005000S



Protex stainless hook for fastener  
18.2005000S

## 18.03507

### Modhold - til kant 11 mm rustfri

Catchplate- for edge 11 mm  
Stainless steel



A: 45,8 mm  
B: 16 mm  
C: 11,2 mm  
D: 8 mm  
E: 14,3 mm  
F: 17,4 mm  
G: 14,7 mm  
H: 2 mm  
I: 34,5 mm  
J: Ø4,1 mm

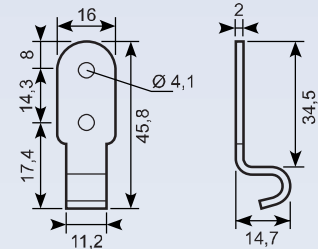

## 18.03535SS

### Modhold - til kant 11 mm rustfri

Catchplate- for edge 11 mm  
Stainless steel



A: 45,8 mm  
B: 16 mm  
C: 11,2 mm  
D: 8 mm  
E: 14,3 mm  
F: 17,4 mm  
G: 14,7 mm  
H: 2 mm  
I: 34,5 mm  
J: Ø4,1 mm

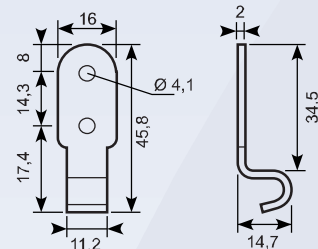

## 18.15AKZN

### Hagebeslag til 18.70ZN 16 mm.

Catchplate for 18.70ZN  
16 mm.

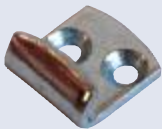

Hage  
B: 15 mm  
L: 16 mm

## 18.01504

### Modhold - plan 16 mm galvaniseret

Catchplate - plane 16 mm  
Zincplated



A: 38,1 mm  
B: 10,5 mm  
C: 4,8 mm  
D: 28,6 mm  
E: 15,9 mm  
F: 1,6 mm  
G: 8 mm  
H: Ø4,1 mm

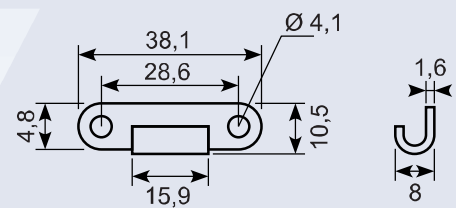

## 18.01504SS

### Modhold - plan 16 mm Rustfri

Stainless steel



A: 38,1 mm  
B: 10,5 mm  
C: 4,8 mm  
D: 28,6 mm  
E: 15,9 mm  
F: 1,6 mm  
G: 8 mm  
H: Ø4,1 mm

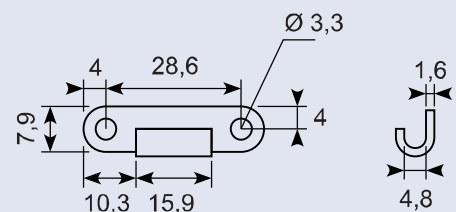

## 18.01613ZN

### Modhold - plan 16 mm galvaniseret

Catchplate - plane 16 mm  
zinc plated



A: 38,1 mm  
B: 10,5 mm  
C: 4,8 mm  
D: 28,6 mm  
E: 15,9 mm  
F: 1,6 mm  
G: 8 mm  
H: Ø4,1 mm

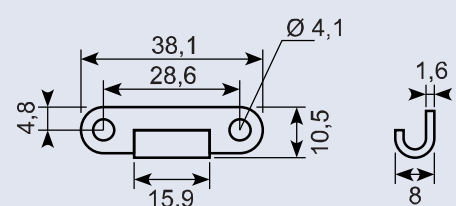

### 18.01658SS



**Modhold - plan 16 mm  
rustfri stål**

Catchplate - plane 16 mm  
stainless steel

A: 40 mm  
B: 23 mm  
C: 16 mm  
D: 5 mm  
E: 30 mm  
F: 1,8 mm  
G: 7,1 mm  
H: Ø4,2 mm

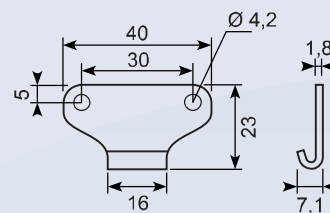

### 18.01658ZN



**Modhold - plan 16 mm  
galvaniseret jern**

Catchplate - plane 16 mm  
zinc-plated

A: 40 mm  
B: 23 mm  
C: 16 mm  
D: 5 mm  
E: 30 mm  
F: 1,8 mm  
G: 7,1 mm  
H: Ø4,2 mm

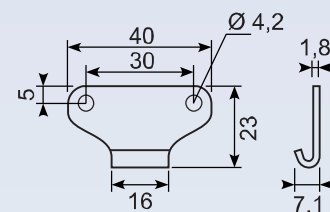

### 18.02613ZN



**Modhold - plan 16 mm  
galvaniseret**

Catchplate - plane 16 mm  
zinc plated

### 18.02633

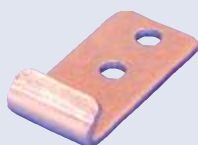

**Hage til 18.27633 m.fl. Zink**

Hook for 18.27633 with more, zinc-plated

A: 31 mm  
B: 15,9 mm  
C: 10,3 mm  
D: 4 mm  
E: 7,8 mm  
F: 1,6 mm  
G: Ø4,1 mm

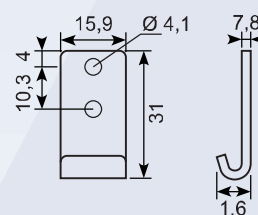

### 18.02633SS



**Hage til 18.276ss.  
Rustfri.**

Stainless

A: 31 mm  
B: 15,9 mm  
C: 10,3 mm  
D: 4 mm  
E: 7,8 mm  
F: 1,6 mm  
G: Ø4,1 mm

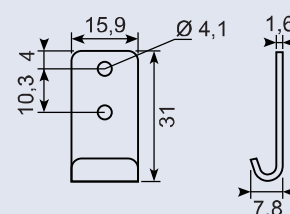

### 18.03613ZN



**Modhold - til kant 16 mm  
galvaniseret**

Catchplate - for edge 16 mm  
zincplated

A: 30,8 mm  
B: 15,9 mm  
C: 4 mm  
D: 10,3 mm  
E: 23 mm  
F: 1,6 mm  
G: 10,3 mm  
H: Ø4,1 mm

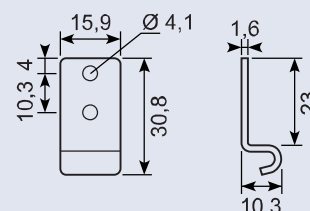

### 18.03655ZN

**Modhold - til kant 16 mm  
galvaniseret jern**

Catchplate - for edge 16 mm  
zinc-plated

A: 40,2 mm  
B: 16 mm  
C: 6,3 mm  
D: 10 mm  
E: 28,5 mm  
F: 1,8 mm  
G: 31,7 mm  
H: 11,2 mm  
I: Ø4,2 mm

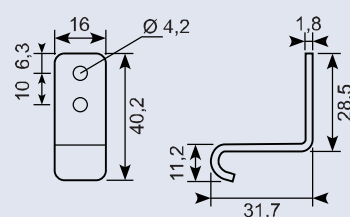

### 18.06625ZN

#### Modhold - til kant 22 mm galvaniseret jern



Catchplate - for edge 22 mm  
zinc-plated

### 18.011273CZN

#### Modhold - plan 22 mm galvaniseret jern



Catchplate - plane 22 mm  
zinc-plated

A: 50,8 mm  
B: 34,9 mm  
C: 22,2 mm  
D: 38,1 mm  
E: 15,9 mm  
F: 15,1 mm  
G: 2 mm  
H: Ø5,1 mm

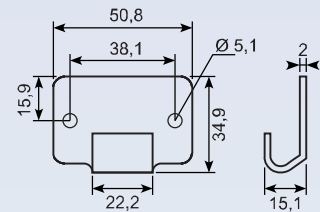

### 18.01575

#### Modhold - plan 22 mm, galvaniseret



Catchplate - plain 22 mm, zinc-plated

A: 22,2 mm  
B: 47,6 mm  
C: 50,8 mm  
D: 15,9 mm  
E: 38,1 mm  
F: 2 mm  
G: 8,3 mm  
H: Ø5,1 mm

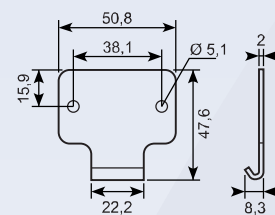

### 18.361058H

#### Modhold - plan 24 mm galvaniseret jern

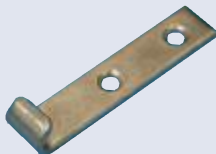

Catchplate - plane 24 mm  
stainless steel

A:  
B: 18 mm  
C: 16 mm  
D: 3 mm  
E: 85 mm  
F: 12 mm  
G:

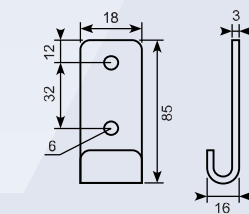

### 18.01502ZN

#### Modhold - plan 24 mm galvaniseret jern



Catchplate - plane 24 mm  
zinc-plated

A: 60,3 mm  
B: 22,2 mm  
C: 19 mm  
D: 44,5 mm  
E: 23,8 mm  
F: 26 mm  
G: 11,9 mm  
H: Ø5,1 mm

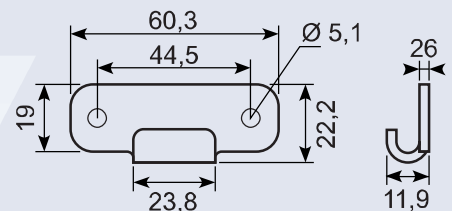

### 18.01502SS

#### Lige beslag - rustfri



Protex stainless hook, equal

### 18.02502SS

#### Modhold - plan 24 mm rustfri



Catchplate - plane 24 mm  
Stainless steel

A: 55,6 mm  
B: 23,8 mm  
C: 2,7 mm  
D: 2,6 mm  
E: 16 mm  
F: 8,7 mm  
G: Ø5,1 mm

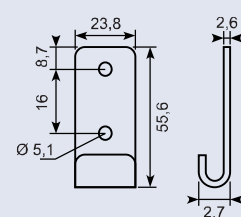

### 18.02502ZN



#### Modhold - plan 24 mm galvaniseret jern

Catchplate - plane 24 mm zinc-plated

A: 55,6 mm  
B: 23,8 mm  
C: 2,7 mm  
D: 2,6 mm  
E: 16 mm  
F: 8,7 mm  
G: Ø5,1 mm

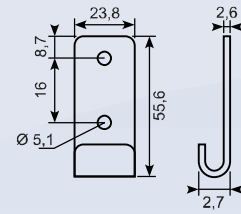

### 18.051058SS



#### Modhold - plan 24 mm rustfri

Catchplate - plain 24 mm Stainless steel

A: 34,9 mm  
B: 50,8 mm  
C: 23,8 mm  
D: 38,1 mm  
E: 8 mm  
F: 12,7 mm  
G: 2,6 mm  
H: Ø5,1 mm

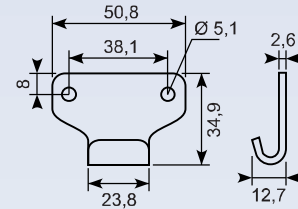

### 18.05502SS



#### Modhold - plan hjerteform 24 mm rustfri

Catchplate - heartshaped plain 24 mm, stainless steel

A: 56,4 mm  
B: 39,6 mm  
C: 23,8 mm  
D: 36,5 mm  
E: 2,6 mm  
F: 12,7 mm  
G: Ø5,1 mm

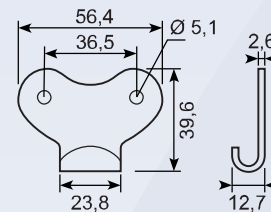

### 18.05502ZN



#### Modhold - plan hjerteform 24 mm Galvaniseret jern

Catchplate - heartshaped plain 24 mm, zinc-plated

A: 56,4 mm  
B: 39,6 mm  
C: 23,8 mm  
D: 36,5 mm  
E: 2,6 mm  
F: 12,7 mm  
G: Ø5,1 mm

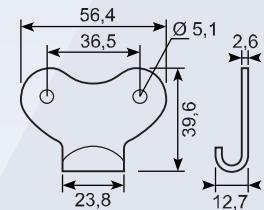

### 18.122H



#### Vinklet modhold til 18.122 Galvaniseret jern. 32 mm.

Angular counterhold for 18.122 Zincplated. 32 mm.

A: 100 mm  
B: 145 mm  
C: 32 mm

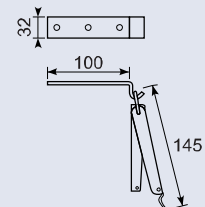

### 18.01507ZN



#### Hage for lukker 19.569A m/flere, forzinket

m/flere, forzinket Hook for fastener 19.569A with more, galvanized

### 18.1010133ZN

#### Hage Nr. 10 forzinket

Hook No. 10, zinc-plated



## Snap- og hagelåse / Claw latches and budget latches

16.100



**Tungelås uden sikring**  
**Hulafstand: 66 mm**  
**Galvaniseret stål med nylontunge, til 8 mm stift.**

Universal budget latch  
 With nylon bolt, for 8 mm T-key

A: 83 mm  
 B: 22 mm  
 C: 66 mm

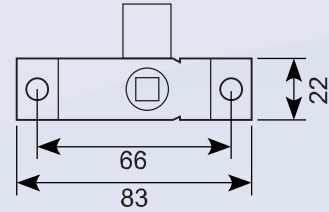

16.100R



**Tungelås uden sikring.**  
**Rustfri stål, til 8 mm stift.**

Stainless steel, for 8 mm T-key

A: 83 mm  
 B: 22 mm  
 C: 66 mm

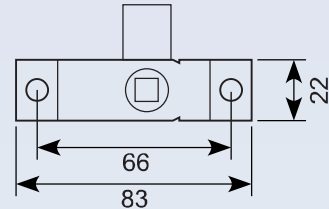

16.100X



**Tungelås uden sikring.**  
**Galvaniseret stål med ståltunge, til 8 mm stift.**

With steel bolt, for 8 mm T-key

A: 83 mm  
 B: 22 mm  
 C: 66 mm

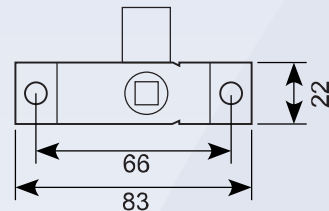

16.101



**Tungelås uden sikring**  
**Galvaniseret stål til 7 mm stift**

Latch lock without safety device  
 Zink-plated steel, for 7 mm pin

A: 100 mm  
 B: 19 mm  
 C: 81 mm

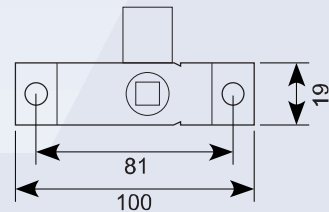

16.102



**Tungelås uden sikring**  
**Galvaniseret jern til 8 mm stift**

Latch lock without safety device  
 Zink-plated steel, for 8 mm pin

A: 125 mm  
 B: 27 mm  
 C: 100 mm

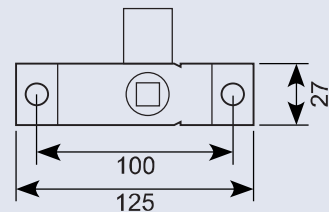

16.103



**Tungelås uden sikring - venstre**  
**Zink-plated stål, til 8 mm stift.**

Handed budget latch - LH  
 Zinc-plated, for 8 mm T-key

A: 83 mm  
 B: 22 mm  
 C: 28 mm  
 D: 66 mm  
 E: 18 mm

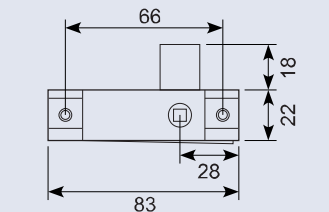

16.104



**Tungelås uden sikring - højre**  
**Galvaniseret stål, til 8 mm. stift.**

Handed budget latch - RH  
Zinc-plated, for 8 mm T-key

A: 83 mm  
B: 22 mm  
C: 28 mm  
D: 66 mm  
E: 18 mm

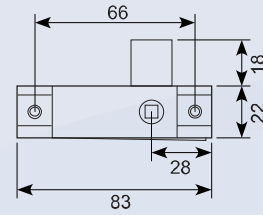

16.107



**Kroglås uden sikring**  
**Galvaniseret stål, til 8 mm. stift.**

Hooked budget latch, LH  
Yellow zincplated, for 8 mm T-key

A: 113 mm  
B: 25 mm  
C: 9 mm  
D: 21 mm  
E: 43 mm  
F: 93 mm

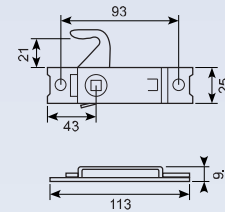

16.108



**Kroglås uden sikring - højre**  
**Galvaniseret stål, til 8 mm stift.**

Hooked budget latch, RH  
Yellow zinc plated, for 8 mm T-key

A: 113 mm  
B: 25 mm  
C: 9 mm  
D: 21 mm  
E: 43 mm  
F: 93 mm

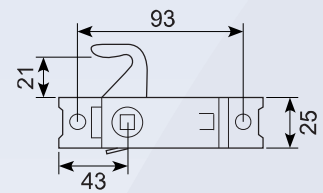

16.179



**Hagelås - venstre**  
**Galvaniseret stål, til 8 mm stift**

Flush fitting lock - LH  
Zink-plated, for 8 mm pin  
Flush fitting lock left

A: 113 mm  
B: 25 mm  
C: 9 mm  
D: 21 mm  
E: 43 mm  
F: 93 mm

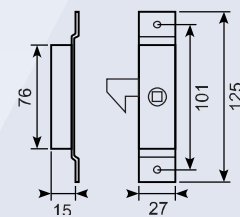

16.180



**Hagelås - højre**  
**Galvaniseret stål, til 8 mm stift.**

Flush fitting lock - RH  
Zink-plated, for 8 mm pin  
Flush fitting lock right

A: 113 mm  
B: 25 mm  
C: 9 mm  
D: 21 mm  
E: 43 mm  
F: 93 mm

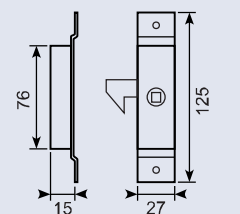

16.190



**Motorrumslås (Gl. VW klaplås)**

Bolt lock c/w spring latch (old VW flap lock)

Bredde: 22 mm  
Længde: 75 mm  
Dybde: 56 mm

50.064110



**Dørlås, galvaniseret**

Door lock

27 x 125 mm  
Hulafstand: 102 mm

● Godt køb / best buy

**50.064120****Dørlås, galvaniseret**22 x 115 mm  
Hulafstand: 94 mm

Door lock

**50.064130****Dørlås, galvaniseret**19 x 105 mm  
Hulafstand: 86 mm

Door lock

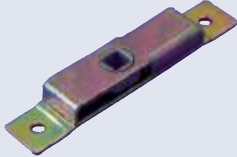
**16.203****Snaplås i galvaniseret stål.**A: 140,5 mm  
B: 75,5 mm  
C: 20 mm  
D: 44 mm

Spring catch, galvanized steel

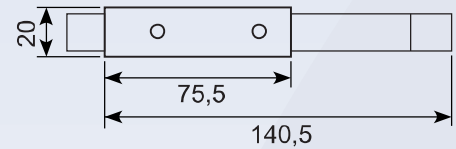
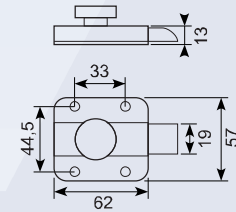
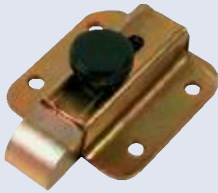
**16.205****Snaplås, galvaniseret stål med knop.**A: 62 mm  
B: 57 mm  
C: 19 mm  
D: 13 mm  
E: 33 mm  
F: 44,5 mmTop-knob latch, nose-down.  
Mild steel**16.205R****Snaplås, rustfrit stål med knop**A: 62 mm  
B: 57 mm  
C: 19 mm  
D: 13 mm  
E: 33 mm  
F: 44,5 mm

Top-knob latch, nose-down SS

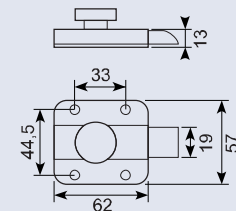
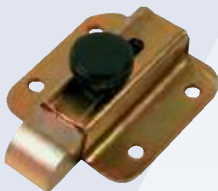
**16.205X****Snaplås i galvaniseret stål med omvendt gæk**A: 62 mm  
B: 57 mm  
C: 19 mm  
D: 13 mm  
E: 33 mm  
F: 44,5 mm

Top-knob latch, nose-up mild steel

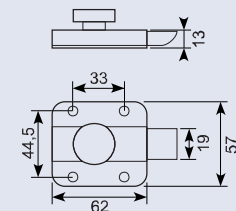
**16.213****Snaplås, galvaniseret stål**A: 75 mm  
B: 20,5 mm  
C: 19,5 mm  
D: 44 mm  
E: 14 mm

Spring catch, galvanized steel

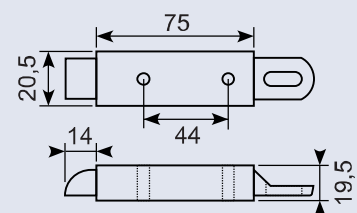

Godt køb / best buy

16.214



**Snaplås, sort kunststof**

Moulded slam latch, black synthetic material

A: 80 mm  
B: 29 mm  
C: 18 mm  
D: 44 mm  
E: 16 mm

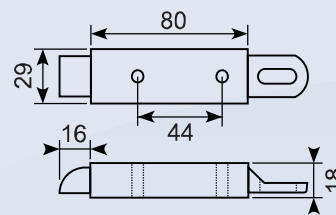

16.216SR



**Snaplås rustfri med øjestang**

Slam latch with eyebar, stainless steel

16.316



**Magnetlås - 2 dele  
El galvaniseret jern.**

Magnetic lock - two parts  
Zinc-plated

L: 46 mm  
B: 14 mm  
H: 18 mm

## Lakajkramper og dørstopper / Door retainer cramps and door retainer straps

22.486D



**Dørstropbeslag - bøjle**  
**Alloy blank**

Door retainer fittings - strap bracket  
Polished chill-cast aluminium

22.486B



**Skrue til dørstropbeslag**  
**22.486H - 22.486V**

Round-head screw for door  
retainer fittings 22.486H - 22.486V

22.486E



**Bolt til dørstropbeslag 22.486D**  
**Krom**

Cylinder screw for door retainer fittings  
22.486H - 22.486V, chrome

22.486F



**Møtrik til bolt 22.486E, krom**

Cheese head nut for bolt 22.486E  
Chrome

22.486H



**Dørstropbeslag - højre**  
**Alloy blank**

Door retainer fittings, RH  
Polished alloy

22.486V



**Dørstropbeslag - venstre**  
**Alloy blank**

Door retainer fittings, LH  
Zinc-plated alloy

22.5486



**Dørstropbeslag - åben**

Door retainer fittings - open

22.5486B



**Bolt med rundt hoved til dørstropbeslag**

Round-head screw for door retainer fittings

22.5486D



**Dørstropbeslag, bøjle Alloy blank**

Door retainer fittings  
Polished chill-cast aluminium

22.5486E



**Bolt for dørstropbeslag, 8 mm**

Cylinder screw 8 mm for door retainer fittings

22.462

**Lakajkrampe 25/64 mm, rustfri**

Door retainer cramp 25 mm - stainless



22.464

**Lakajkrampe 40/68 mm, galvaniseret**

Door retainer cramp 40/68 mm  
Zinc-plated



22.464CR

**Lakajkrampe 40/68 mm, krom**

Door retainer cramp 40/68 mm  
Chrome-plated



## 22.4865S



### Rustfri dorn til dørstropbeslag 22.486H - 22.486D

Cylinder screw, stainless  
for door retainer fittings  
22.486H - 22.486D

## 22.486C



### Fiberrør til dørstropbeslag 22.486H - 22.486V og 22.5486

Fiber tube for door retainer fittings 22.486H -  
22.486V and 22.5486

## Dørstropper

Vare nr.	B	L
	mm	mm
22.413	40	160
22.414	40	200
22.426	60	200
22.427	60	230
22.5426	60	230
22.428	60	250
22.5428	60	270

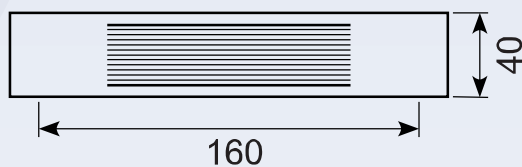
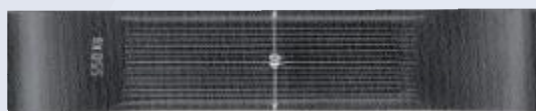

### Dørstropper Gummi med lærredsindlæg.

Door retainer straps  
Black rubber with textile insert

## Dør- og hjelmholder / Door retainers and fasteners

### 22.641J



**Dørholder - Hans & Grete, komplet  
Gummi/PVC**

Rubber door holder  
Hard, black rubber with 6 mm hole

Hun: 35 mm x Ø40  
mm  
Han: 27 mm x Ø25  
mm

### 22.642J



**Dørholder - hun-del  
Hård sort gummi med 6 mm montagehul  
Til dørholder 22.641J**

Rubber door holder - female  
Hard, black rubber with 6 mm hole  
For door holder 22.641J

### 22.643



**Dørholder - han-del  
Sort PVC med 6 mm montagehul**

Door holder - male  
Black polypropylene with 6 mm hole

### 22.662R



**Dørholder med udløser - hun-del  
Ud- og indvendig udløser.  
Metal med PVC kappe.**

Door retainer - female  
External and internal release.  
Metal with PVC body.

A: 62 mm  
B: 18 mm  
C: 26 mm  
D: 40 mm  
E: 35 mm  
F: Ø6 mm

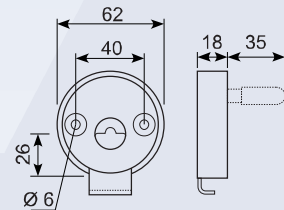

### 22.663R



**Dørholder med gummimuffe, han-del  
Til 22.661R og 22.662R**

Door retainer - male part  
Encased in black, nitrile bellows  
For 22.661R and 22.662R

A: 45 mm  
B: 38 mm  
C: 12,5 mm  
D: 23 mm  
E: M6

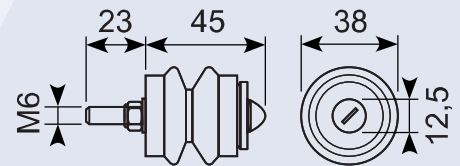

### 22.655



**Dørholder med udløser, komplet  
Dobbeltudløser udv./indv.  
Metal med PVC kappe, galvaniseret pal**

Door retainer with release, complete  
External/internal release  
Metal with PVC buffer, zinc-plated pal

A: 75 mm  
B: 19 mm  
C: 27,5 mm  
D: 14 mm  
E: 39,5 mm  
F: 22 mm  
G: Ø54 mm

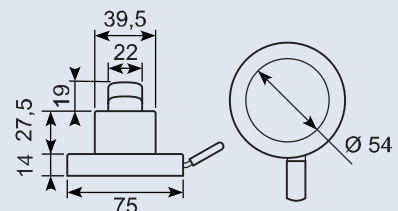

Godt køb / best buy



**22.656**



**Dørholder m. udvendig udløser, komplet  
Metal med PVC kappe, galvaniseret pal**

Door retainer with release, complete  
Metal with PVC buffer, zinc-plated latch

- A: 75 mm
- B: 19 mm
- C: 27,5 mm
- D: 14 mm
- E: 39,5 mm
- F: 22 mm
- G: Ø54 mm

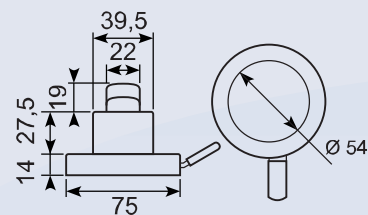

**22.661R**



**Dørholder med udløser - hun-del  
Udvendig udløser, metal med PVC kappe**

Door retainer - female  
External release. Metal with PVC body

- A: 62 mm
- B: 18 mm
- C: 26 mm
- D: 40 mm
- F: Ø6 mm

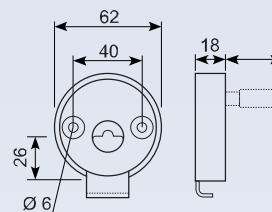

**22.5556**



**Han-del til dørholder, aluminium**

38 x 15 mm

Male part for door retainer fittings Aluminium

**22.5557**



**Hun-del til dørholder, aluminium**

52 x 25 mm

Female part for door retainer fittings  
Aluminium

**22.5558**

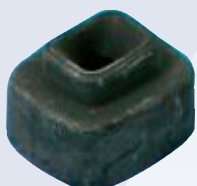

**Gummi-del for 22.557 (22.5557)**

Rubber part for 22.557 (22.5557)

**22.5562**



**Dørholder - han-del, aluminium**

70 x 30 mm.  
Tap : 40 mm.

Door retainer fittings - male part aluminium

**22.5563**

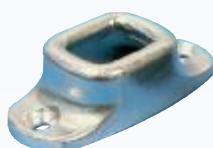

**Dørholder - hun-del, aluminiumshus**

86 x 44 mm

Door retainer fittings - female  
Aluminium casing

22.5564



**Gummilås for dørholder**  
**Passer til 22.563/22.5563**

Rubber buffer  
Fits part Nos. 22.563/22.5563

22.556



**Dørholder - han, aluminium**

38 x 15 mm

Door retainer fittings, male part  
Aluminium

22.557

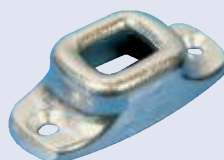

**Dørholder - hun-del, aluminiumshus**

52 x 25 mm

Door retainer fittings - female  
Aluminium casing

22.558

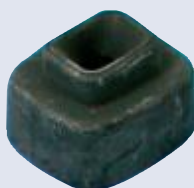

**Gummilås for dørholder**  
**Passer til 22.557**

Rubber buffer for door retainer fittings, fits  
22.557

22.562



**Dørholder - han-del, aluminium**

70 x 30 mm

Tap: 40 mm

Door retainer fittings - male  
Aluminium

22.563

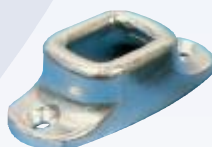

**Dørholder - hun-del, aluminiumshus**

86 x 44 mm

Door retainer fittings - female  
Aluminium casing

22.564

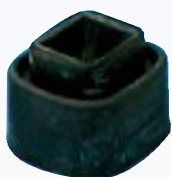

**Gummilås for dørholder**  
**Passer til 22.563/22.5563**

Rubber buffer  
Fits part Nos. 22.563/22.5563

22.664

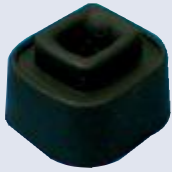

**Dørholder - gummilås**  
Passer til 22.667.

Door retainer fittings - rubber buffer  
Fits 22.667

22.667



**Dørholder - hun, aluminium.**

66 x 34 mm

Door retainer fittings - male  
Aluminium

22.668



**Dørholder - han. Aluminium.**

38 x 15 mm  
Tap: 15,5 mm

Door retainer fittings - male  
Aluminium

22.5572



**Dørholder - han, aluminium**

70 x 30 mm  
Tap: 60 mm

Door retainer fittings - male 60  
aluminium

22.5582



**Dørholder - han-del, aluminium**

70 x 30 mm  
Tap: 80 mm

Door retainer fittings - male part  
Aluminium

22.572



**Dørholder - han-del, aluminium**

70 x 30 mm.  
Tap: 60 mm

Door retainer fittings - male  
Aluminium

22.648

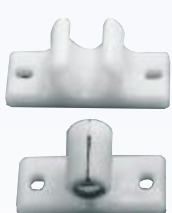

**Dørholder justerbar - komplet**  
Hvid nylon.

Door retainer with adjustable grip  
White nylon

A: 67 mm  
A1: 57 mm  
B: 25 mm  
C: 41 mm  
D: 7,5 x 4,5 mm

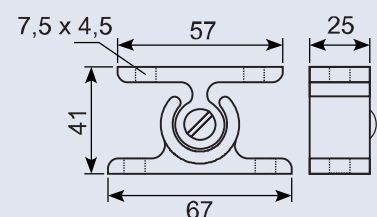

## 22.648FJ



### Hvid nylon dørholder, hun-del

White nylon door retainer  
Female part



## 22.644



### Nylon underlag til 22.648FJ Kuldebestandig, Hvid.

57 x 25 x 4 mm

Nylon washer for 22.648HJ  
cold resistant, white



## 22.648HJ



### Hvid nylon dørholder, han-del

White door retainer, male



## 22.645



### Nylon underlag til 22.648HJ Kuldebestandig, hvid

66 x 25 x 4 mm

Nylon washer F/22.648FJ  
cold resistant, white

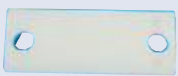

## 22.648J



### Dørholder justerbar - komplet Hvid nylon

Door retainer with adjustable grip  
White nylon



A: 67 mm  
A1: 57 mm  
B: 25 mm  
C: 41 mm  
D: 7,5 x 4,5 mm

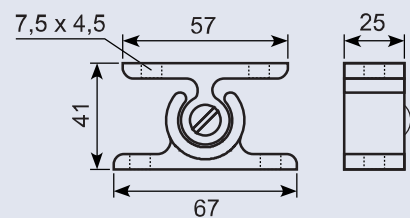

## 22.650J



### Dørholder med fjeder - komplet Hvid nylon

Door retainer with spring - complete  
White nylon



A: 65 mm  
B: 29 mm  
C: 43 mm  
D: 4,5 mm

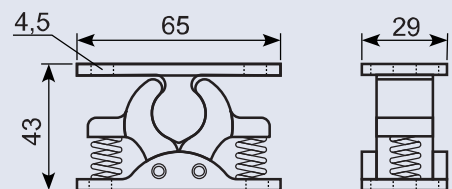

## 22.646

### Dørholder med fjeder - komplet Galvaniseret støbejern med rustfri fjeder.

Door retainer with spring, complete  
Malleable iron casting w. zinc-plated finish,  
stainless spring



A: 66 mm  
A1: 62 mm  
B: 21 mm  
C: 42 mm  
D: 4,5 mm

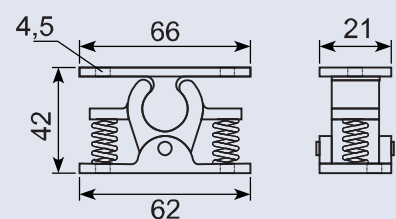

Godt køb / best buy

## 22.646H



### Hun-del for dørholder Med galvaniseret finish

Female part for door retainer 22.646 with a zinc-plated finish

## 22.632



### Dørholder uden fjeder - han Galvaniseret jern Door hook, no spring - male Zinc-plated, cast iron

A: 100 mm  
B: 45 mm  
C: 77 mm  
D: 59 mm  
E: 25,4 mm  
F: Ø5,5 mm

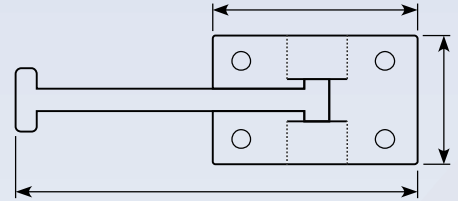

## 22.633



### Dørholder modhold med fjederlås Hun-del, galvaniseret

Plant-on catch plate with spring  
Female, zinc-plated

A: 45 mm  
B: 77 mm  
C: 59 mm  
D: 25,4 mm

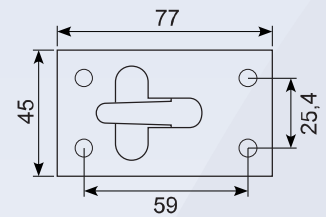

## 50.051071S

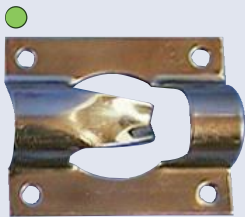

### Dørholder, hun-del, Rustfri Door holder, female part, stainless

A: 50 mm  
B: 63,5 mm  
C: 38 mm  
D: 50 mm  
E: Ø4,5 mm

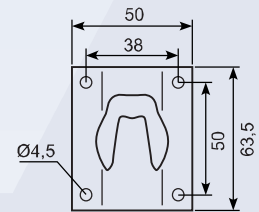

## 50.051072S



### Dørholder, han-del, rustfri Door holder, male part, stainless

A: 58 mm  
B: 58 mm  
C: 41 mm  
D: 41 mm  
E: 98 mm  
F: Ø4,5 mm

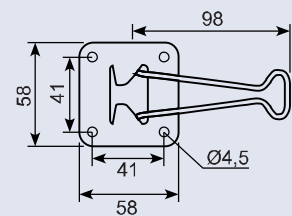

## 50.DL4010

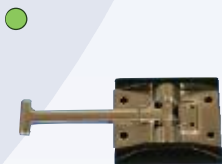

### Dørholder. Rustfri han-del

Stainless mail part

## 50.DL4020



### Dørholder Rustfri hun-del

Stainless female part

● Godt køb / best buy

### 54.300010

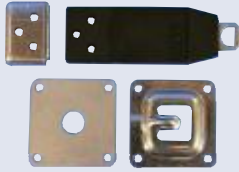

#### Dørholder komplet, længde 103 mm

Complete door retainer, 103 mm

A: 6 mm  
B: 6 mm  
C: 5 mm  
D: 5 mm  
E: 72 mm  
F: 31 mm  
G: 20 mm  
H: 45 mm  
I: 10 mm  
J: 10 mm  
K: 12 mm  
L: 8 mm  
M: Ø5,5 mm

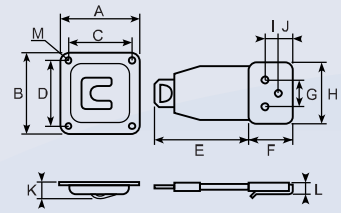

### 54.300015



#### Plade til dørholder 54.300010 og 54.300020

Plate for door retainer 54.300010 and 54.300020

### 54.300016

#### Polyurethanbånd

72 mm

Polyurethane belt

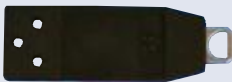

### 54.300020



#### Dørholder komplet, længde 123 mm

Complete door retainer, 123 mm

A: 6 mm  
B: 6 mm  
C: 5 mm  
D: 5 mm  
E: 92 mm  
F: 31 mm  
G: 20 mm  
H: 45 mm  
I: 10 mm  
J: 10 mm  
K: 12 mm  
L: 8 mm  
M: Ø5,5 mm

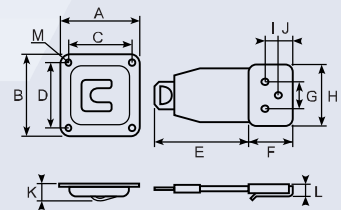

### 54.300026

#### Polyurethanbånd

92 mm

Polyurethane belt

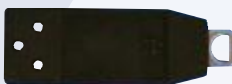

### 53.153



#### Hjelmholder 100 mm, lige, komplet 100 mm.

Engine cover fastener, straight rod

A: 100/130 mm  
B: 23 mm  
C: 40 mm  
D: 35 mm  
E: 28 mm  
F: 13 mm  
H: Ø6 mm

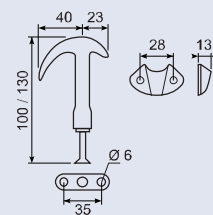

**53.165****Hjelmholder komplet, galvaniseret jern** 65 mm

Fastener 65 mm, zinc-plated iron

**53.165J****Hjelmholder komplet, galvaniseret jern** 65 mm

Fastener 65 mm, zinc-plated iron

**53.165SJ****Hjelmholder komplet, rustfrit stål** 65 mm

Fastener 65 mm, SS

**53.166****Gummidel til hjelmholder** 65 mm

Rubber part for fastener

**53.166J****Gummidel til hjelmholder** 65 mm

Rubber part for fastener

**53.167****Bundbeslag til hjelmholder** 65 mm  
**Galvaniseret jern**Fastening plate for fastener  
Zinc-plated iron**53.168****Gummidel til hjelmholder** 65 mm  
**Galvaniseret jern**Rubber part for fastener  
Zinc-plated iron

Godt køb / best buy

53.169

**Split - Skive - Bolt til hjelmholder.** 65 mm  
**Galvaniseret jern.**

Fittings for 65 mm fastener  
Zinc-plated iron

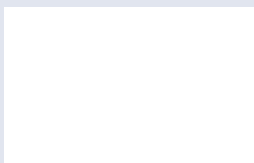

53.171

**Hjelmholder komplet. Galvaniseret jern** 130 mm

Fastener 130 mm  
Zinc-plated iron



53.171J



**Hjelmholder komplet. Galvaniseret jern.** 130 mm

Fastener 130 mm  
Zinc-plated iron



53.171S

**Hjelmholder komplet. Rustfrit stål.** 130 mm

Fastener 130 mm  
Stainless steel



53.171SJ



**Hjelmholder komplet. Rustfrit stål.** 130 mm

Fastener 130 mm  
Stainless steel



53.172

**Gummidel til hjelmholder** 130 mm

Rubber part for 130 mm fasteners



53.172J



**Gummidel til hjelmholder** 130 mm

Rubber part for 130 mm fasteners



 Godt køb / best buy



53.173

**Bundbeslag til hjelmholder. Galvaniseret jern** 130 mm



Fastener plate for 130mm fasteners  
Zinc-plated iron

53.173S

**Bundbeslag til hjelmholder. Rustfrit stål** 130 mm



Fastener plate for 130 mm fasteners  
Stainless steel

53.174

**Hagedel til hjelmholder. Galvaniseret jern** 130 mm



Hook part for 130 mm fasteners  
Zinc-plated iron

53.174S

**Hagedel til hjelmholder. Rustfrit stål** 130 mm



Hook part for 130 mm fasteners  
Stainless steel

53.175

**Split - Skive - Bolt til hjelmholder. Galvaniseret jern** 130 mm



Fittings for 130 mm fasteners  
Zinc-plated iron

53.175S

**Split - Skive - Bolt til hjelmholder. Rustfrit stål** 130 mm



Fitting for 130 mm fasteners  
Stainless steel

22.146

**Låsekiler, aluminium**

Striker, Alloy



A: 38 mm  
B: 32 mm  
C: 16 mm  
D: 8 mm  
E: 11 mm  
F: 20 mm  
G: 7 mm

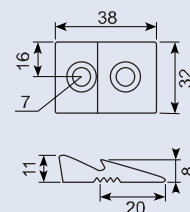

22.251



**Dørkile - lille**  
**Hun: alloy/han: gummi**

L: 25 mm  
B: 60 mm

Dovetail - small  
Female: alloy/male: rubber

22.251G

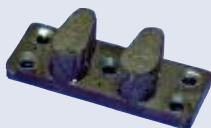

**Gummibuffe for dørkile**

Rubber buffer for door wedge (dovetail)

22.255

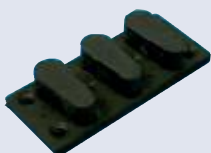

**Dørkile - stor**  
**Hun: alloy/han: gummi**

L: 35 mm  
B: 78 mm

Dovetail - large  
Female: alloy/male: covered with rubber

## Håndtag og bøjlegreb / Handles and door handles

### 54.830100J



#### Plastikgreb, sort

Pull handle plastic, black.  
Distance between holes 203 mm

245 x 40 mm  
Hulafstand 203 mm



### 54.830200J



#### Bøjlegreb - blød sort PVC med stålindlæg. Monteret fra forsiden med skjulte skruer - stålindlæg

Soft PVC handle with steel core

A: 185 mm  
B: 160 mm  
C: 30 mm  
D: 55 mm  
E: Ø8 mm

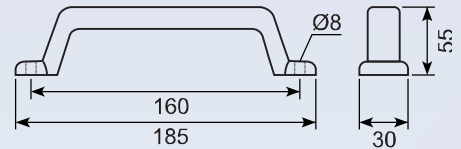

### 54.830210J



#### Bøjlegreb - blød sort PVC. Med stålindlæg. Monteret fra forsiden.

Soft PVC handle with steel core 11" 280 x 55 mm.

A: 280 mm  
B: 250 mm  
C: 30 mm  
D: 55 mm  
E: Ø8 mm

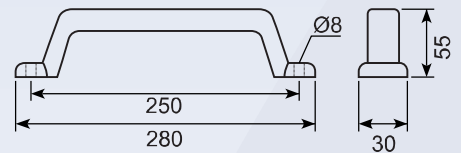

### 18.426652

#### Bøjlegreb - sort kunststof 92 mm

Pull handle - black synthetic material 92 mm

A: 113 mm  
B: 38 mm  
C: 22 mm  
D: 92 mm

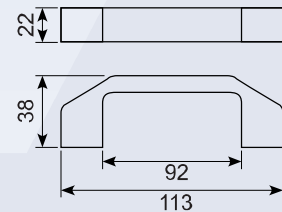

### 18.426654

#### Bøjlegreb - hvid kunststof 92 mm

Pull handle - white synthetic material 92 mm

A: 113 mm  
B: 38 mm  
C: 22 mm  
D: 92 mm

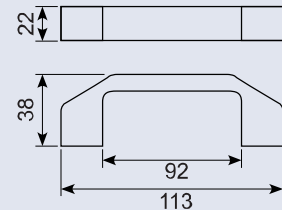
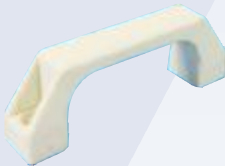

### 23.2362J



#### Bøjlegreb - sort kunststof Monteret fra forsiden.

Pull handle - black synthetic  
Mounted from the front

A: 133 mm  
B: 40 mm  
C: 22 mm  
D: 114 mm

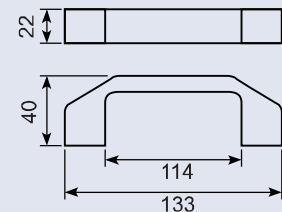

Godt køb / best buy

23.220



**Bøjlegreb - sort kunststof**  
**Monteret fra forsiden med skjulte skruer**

Grab handle - black polypropylene  
 Integral snap-shut to conceal fixing holes

A: 140 mm  
 B: 38 mm  
 C: 173 mm

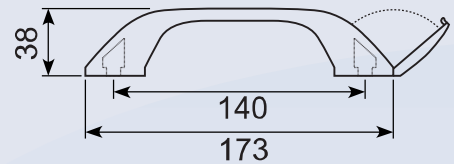

23.2201



**Bøjlegreb - sort kunststof**  
**Monteret fra forsiden**

Pull handle - black synthetic material  
 Mounted from the front

A: 142 mm  
 B: 40 mm  
 C: 26 mm  
 D: 98 mm

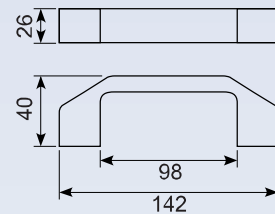

18.422652



**Bøjlegreb - sort kunststof 145 mm**

Pull handle - black synthetic material 145 mm

A: 145 mm  
 B: 40 mm  
 C: 25 mm  
 D: 125 mm

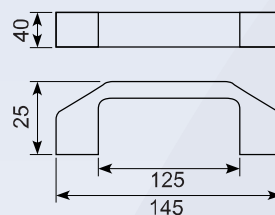

18.422654

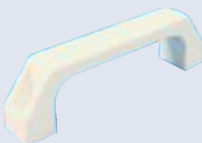

**Bøjlegreb - hvid kunststof 145 mm**

Pull handle - white synthetic material 145 mm

A: 145 mm  
 B: 40 mm  
 C: 25 mm  
 D: 125 mm

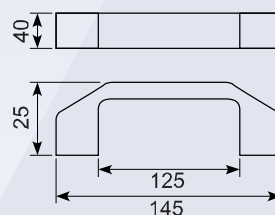

23.230



**Forsat bøjlegreb - sort kunststof**  
**Med stålindlæg, mont. fra forsiden med skjulte skruer.**

Foamed steel-cored grab rail  
 black polyurethane, mounted from the front  
 with concealed screws.

A: 300 mm  
 B: 102 mm  
 C: 75 mm  
 D: 155 mm  
 D1: 213 mm  
 E: 25 mm  
 F: Ø7mm

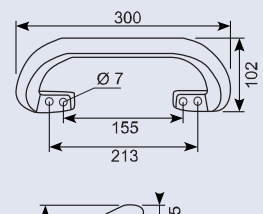

23.231



**Forsat bøjlegreb - sort kunststof**  
**Med stålindlæg, mont. fra forsiden med skjulte skruer.**

Foamed steel-cored grab rail  
 black polyurethane, mounted from the front  
 with concealed screws.

A: 470 mm  
 B: 100 mm  
 C: 75 mm  
 D: 332 mm  
 D1: 375 mm  
 E: 32 mm  
 F: Ø7 mm

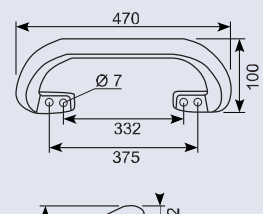

23.207X



**Bøjlegreb - sortlakeret**  
**Monteret fra bagsiden.**

Grab handle - black powder-coated  
 Mounted from the back

A: 114 mm  
 B: 32 mm

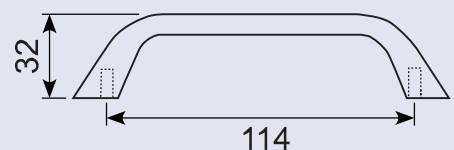

23.232



**Bøjlegreb - sortlakeret aluminium**  
**Monteret fra forsiden.**

Grab rail - black powder-coated  
Mounted from the front

A: 239 mm  
B: 35 mm  
C: 253 mm

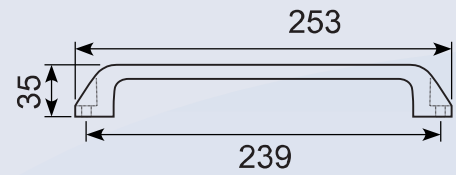

23.208



**Bøjlegreb - mat aluminium.**  
**Monteret fra forsiden**

Grab handle - anodized aluminium  
Mounted from the front

Hulafstand: 140 mm  
Højde: 37 mm

23.244



**Bøjlegreb - poleret aluminium**  
**Monteret fra forsiden.**

Door pull - polished aluminium  
Mounted from the front

Hulafstand: 113 mm  
Højde: 31 mm

23.246



**Bøjlegreb - poleret aluminium.**  
**Monteret fra forsiden.**

Door pull - polished aluminium  
Mounted from the front

Hulafstand: 143 mm  
Højde: 54 mm

23.207



**Bøjlegreb - forkromet**  
**Monteret fra bagsiden.**

Cabinet handle - chrome  
Mounted from the back

A: 89 mm  
B: 25 mm

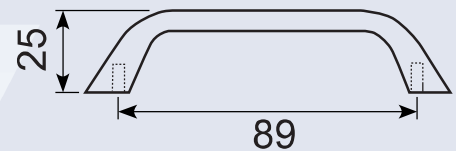

23.214

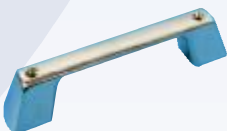

**Bøjlegreb - forkromet**  
**Monteret fra forsiden**

Grab Handle - chrome  
Mounted from the front

Hulafstand/Hole centres: 138 mm  
Højde/Height: 43 mm  
Hul/Hole size: Ø5 mm

23.216



**Bøjlegreb - forkromet.**  
**Monteret fra forsiden.**

Grab handle - chrome-plated  
Mounted from the front

A: 165 mm  
B: 40 mm  
C: 42 mm  
D: 140 mm  
E: 22 mm

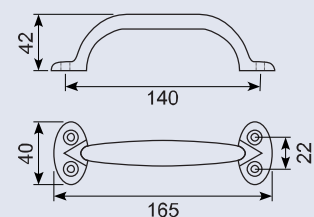

23.217

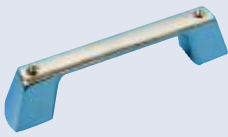

**Bøjlegreb - forkromet.  
Monteret fra bagsiden.**

Grab handle - chrome  
Mounted from the back

Hulafstand/Hole  
centres: 138 mm  
Højde/Height: 43  
mm  
Hul/Hole size: Ø5  
mm

23.224



**Bøjlegreb - forkromet.  
Monteret fra forsiden.**

Grab handle - chrome  
Mounted from the front

Hulafstand: 168 mm  
Højde: 45 mm  
Længde: 190 mm  
Ø: 6 mm

23.226



**Bøjlegreb - forkromet  
Monteret fra forsiden**

Pull handle - chrome-plated  
Mounted from the front

A: 245 mm  
B: 43 mm  
C: 182 mm  
D: 209 mm  
E: Ø 6,5 mm  
F: 51 mm

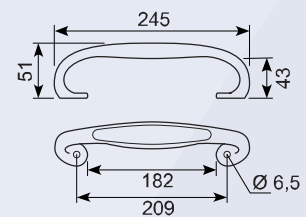

## Bøjlegreb

**Bøjlegreb - forkromet  
Monteret fra bagsiden.**

Steel rail - chrome  
Mounted from the back



Vare nr.	A	B	Materiale/Material
	mm	mm	
23.205	48	96	Krom/Chrome
23.205R	48	96	Rustfri/SS
23.206	48	158	Krom/Chrome
23.206R	48	158	Rustfri/SS

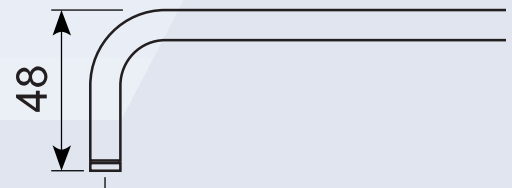

18.637



**Håndtag - fjederbelastet - 110 mm  
Galvaniseret med plastovertrukket  
greb og stor base.**

Handle, spring-loaded, 110 mm -  
zinc-plated with plastic-coated handle and  
large base.

18.638J

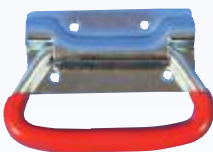

**Kuffertgreb. PVC-overtrukket bøjle.  
Galvaniseret**

Trunk handle, zinc-plated, with red PVC  
cover

● Godt køb / best buy

## 18.931044AZ

### Håndtag - løst - 110 mm Galvaniseret med plastovertrukket greb



Handle, loose, 110 mm -  
zinc-plated with plastic grip

## 18.931044BZ

### Base til løst håndtag. Galvaniseret jern



Base plate for loose handle -  
zinc-plated

## 23.249

### Indbygningshåndtag - sort kunststof Monteret fra forsiden



Double-sided flush-fit grab handle  
Black synthetic material

A: 230 mm  
B: 170 mm  
C: 30 mm  
D: 22 mm  
E: 203 mm  
F: 153 mm  
G: Ø5 mm

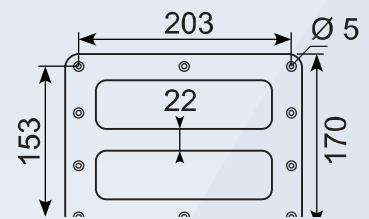

## 23.250

### Indbygningshåndtag - sort kunststof Monteret fra forsiden



Double-sided flush-fit grab handle  
Black synthetic material

A: 133 mm  
B: 60 mm  
C: 21 mm  
D: 95 mm  
E: 45 mm  
F: 41 mm  
G: Ø6 mm

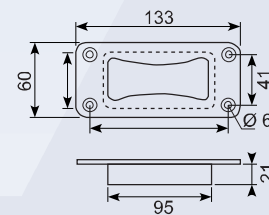

## 23.251J



### El-forzinket skålgreb. Porthåndtag

200 x 90 mm  
Dybde 24 mm

Aluminium step, high-polished front



## 50.125J



### Galvaniseret dybtrækskål m. 2 skruehuller

90 x 20 mm  
Dybde: 24 mm

Zinc-plated bowl with two screw holes



50.9576-3



Varmt galv. Hængsel  
m. messing tap, højre

Hot dip hinge with brass pin, right model

Bredde: 40 mm  
Højde: 75 mm  
Tykkelse: 2,5 mm

Svejselhængsler



Vare nr.	Mål	mm
50.034M	5 x 40	
50.038M	8 x 80	
50.034	5 x 40	
50.035	5 x 50	
50.036	6 x 60	
50.036M	6 x 60	
50.037	6 x 70	
50.038	8 x 80	
50.040	10 x 100	
50.040M	10 x 100	
50.042	11 x 120	
50.042M	11 x 120	
50.043	12 x 135	
50.045	13 x 150	



Svejselhængsel, stål, messing stift, messing skive

Welding hinge, steel, brass pin, brass washer

Svejselhængsler



Vare nr.	Mål	mm
50.038N	6 x 80	
50.040N	8 x 100	
50.042N	11 x 120	
50.043N	12 x 135	
50.045N	13 x 150	

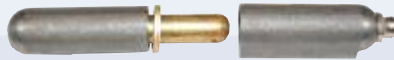

Svejselhængsel, stål, messing stift, messing skive samt smørenippel

Welding hinge, steel, brass pin, brass washer and lubricating nipple

Svejselhængsler



Vare nr.	Mål	mm
50.038A	6 x 80	
50.040A	8 x 100	
50.042A	11 x 120	
50.043A	13 x 150	



Svejselhængsel, aluminium, rustfri stift, messing skive

Welding hinge, aluminium, stainless pin, brass washer

Svejselhængsler



Vare nr.	Mål	mm
50.036S	6 x 60	
50.038S	8 x 80	
50.040S	10 x 100	
50.042S	11 x 120	
50.045S	13 x 150	



Svejselhængsel, rustfri, rustfri stift, rustfri skive

Welding hinge, stainless 304, stainless pin, stainless washer

● Godt køb / best buy



## Svejselhængsler

Vare nr.	Mål	mm
20.034M	5 x 40	
20.038FM	8 x 80	
20.038FS	8 x 80	
20.038M	8 x 80	
20.040FM	10 x 100	
20.042FS	11 x 120	
20.044FM	11 x 140	

OBS ståldorn



**Svejselhængsler med flade ender  
Med messingring og messingdorn**

Weld-on hinges - ending flat  
With brass ring and brass pin

## Svejselhængsler

Vare nr.	Mål	mm
20.034	5 x 40	
20.035	5 x 50	
20.036	6 x 60	
20.037	6 x 70	
20.038	8 x 80	
20.040	10 x 100	
20.040M	10 x 100	
20.042	11 x 120	
20.043	12 x 135	
20.045	13 x 150	

OBS messingdorn



**Svejselhængsler med runde ender  
Med messingring og ståldorn.**

Weld-on hinges - ending round  
With brass ring and steel pin

## Svejselhængsler

Vare nr.	Mål	mm
20.038N	8 x 80	
20.040N	10 x 100	
20.042N	11 x 120	
20.050X	16 x 200	



**Svejselhængsler med smørenippel  
Med runde ender og messingdorn.**

Weld-on hinges with grease nipple  
Ending round, with brass pin

## Svejselhængsler

Vare nr.	Mål	mm
20.036S	6 x 60	
20.038S	8 x 80	
20.040S	10 x 100	
20.045S	13 x 150	



**Svejselhængsler - rustfri  
Med flade ender og ståldorn.**

Weld-on hinges - stainless steel  
Ending flat, with steel pin

## Bladhængsler

Vare nr.	B	L	T	D
	mm	mm	mm	mm
20.133	30	30	5	6
20.136	30	60	5	6
20.143	40	30	5	6
20.146	40	60	5	6
20.148	40	80	5	6
20.150	40	100	5	6
20.156	50	60	5	6
20.270	50	80	6	8
20.158	50	80	6	8
20.160	50	100	5	8
20.162	50	120	6	8
20.166	60	60	5	8
20.168	60	80	6	8
20.170	60	100	6	8
20.172	60	120	6	8
20.180	70	100	6	8
20.271	70	120	6	8
20.190	80	100	6	8

### Bladhængsler Ubehandlet støbejern. Dorn

Straight hinges  
Raw cast iron

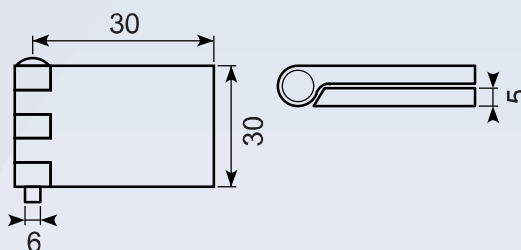

### 20.141

#### Hængsel i ubehandlet støbejern

35 x 60 x 5.5 mm



Hinge

### 20.156S

#### Bladhængsler Ubehandlet støbejern. Dorn Med smørenippel

B: 50 mm  
L: 60 mm  
T: 5 mm  
D: 6 mm



Straight hinge  
Raw cast iron  
With grease nipple

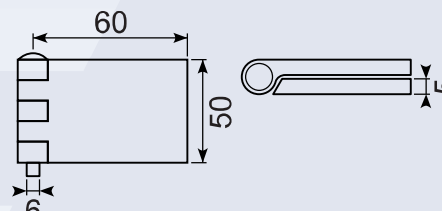

### 20.160S

#### Hængsel med smørenippel i ubehandlet støbejern.

50 x 100 mm



Hinge with grease nipple

## Bladhængsler

Vare nr.	B	L	T
	mm	mm	mm
20.389B	28	80	1,2
20.390	43	100	1,7
20.389A	43	100	1,7



### Bladhængsel uden huller Pladejern ubehandlet.

Rolled hinge without holes  
Mild steel plate

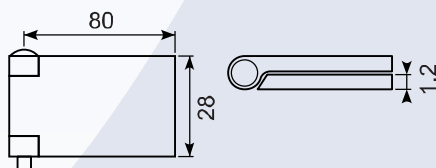

20.257

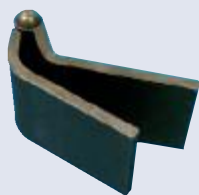

**Bladhængsel, bøjet  
Støbejern, ubehandlet.**

Cranked hinge  
Raw cast iron

B: 50 mm  
L: 70 mm  
Lb: 30 mm  
T: 6 mm  
D: 8 mm

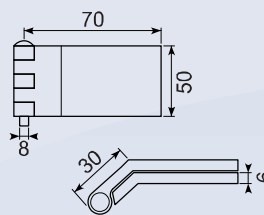

21.460

**Hængseldorn 8 x 55 mm med  
smørenippel**

Pin with grease nipple



21.482

**Hængseldorn med smørenippel**

Pin with grease nipple



## Hængseldorne

Vare nr.	Mål	
	mm	
21.165	6,5	65
21.170	7	65
21.175	7,5	65
21.180	8	85
21.185	8,5	85
21.195	9,5	85
21.205	10,5	85
21.210	11	78
21.282	8	85
21.462	8	65



**Hængseldorne - jern. Drejet af meterstål.**

Pins - iron. Turned of metric steel

med nippel  
med nippel

## Stanghængsler

Vare nr.	L	T	Ø	B
	mm	mm	mm	mm
20.544	2000	1,5	4	40
20.644S	2000	1,5	4	40
20.564	2000	1,5	6	40
20.664S	2000	1,5	6	60
20.565	2000	1,5	6	50
20.566	2000	1,5	6	60
20.584	2000	1,5	8	40
20.585	2000	1,5	8	50
20.587	2000	1,5	8	70

**Stanghængsel - ubehandlet jern/Piano**

Piano hinge - raw iron

rustfri/stainless

rustfri/stainless

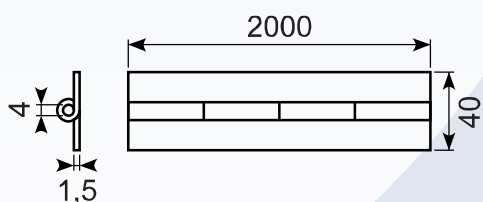
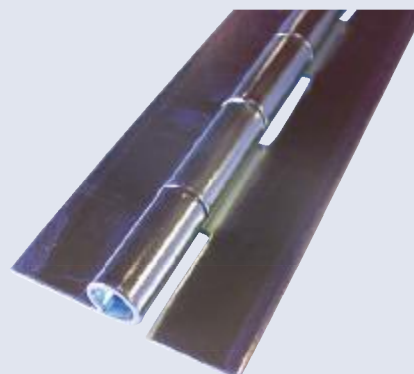

## Stanghængsler

Vare nr.	L	T	Ø	B
	mm	mm	mm	mm
20.664	2000	1,5	6	40
20.665	2000	1,5	6	50
20.666	2000	1,5	6	60
20.666A	2000	1,5	4	60
20.684	2000	1,5	8	40
20.685	2000	1,5	8	50
20.686	2000	1,5	8	60
20.687	2000	1,5	8	70
20.688	2000	1,5	8	80
20.689	2000	1,5	8	90
20.700	2000	1,5	9,5	100
20.701	2000	1,5	9,5	110
20.710	2000	3	9,5	100
20.710X	2500	3	9,5	100
20.711	2000	3	9,5	110

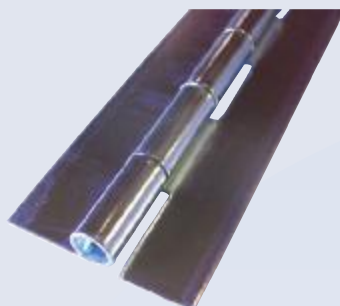

Stanghængsel - el-galvaniseret jern.

Continuous hinge - electroplated

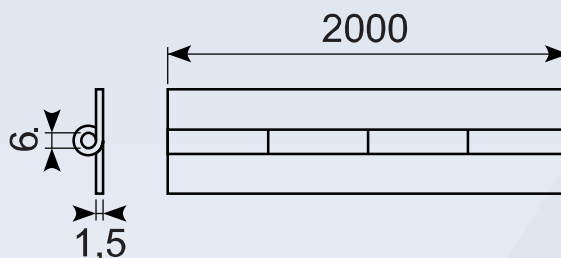

### 20.411

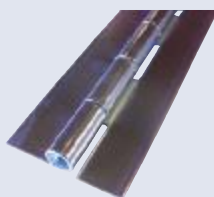

Stanghængsel - jern uden huller

Piano hinge - iron, unpierced

B: 32 mm  
L: 3,5 mtr  
Ø: 1,75 mm  
T: 1,0 mm

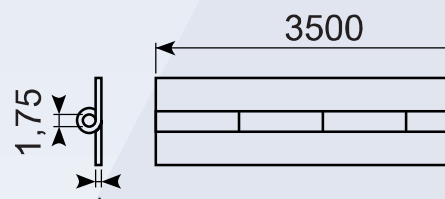

### 20.420

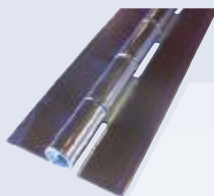

Stanghængsel - rustfri uden huller

Piano hinge - stainless steel, unpierced

B: 32 mm  
L: 3,5 mtr  
Ø: 1,75 mm  
T: 1,0 mm

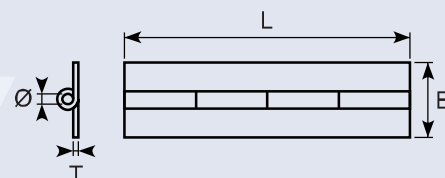

### 20.487

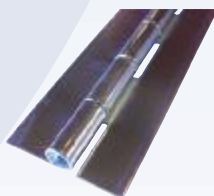

Stanghængsel - blank messing

Piano hinge for folding door  
Bright brass

L: 2000 mm  
B: 70 mm  
Ø: 8 mm jern  
T: 1,5 mm

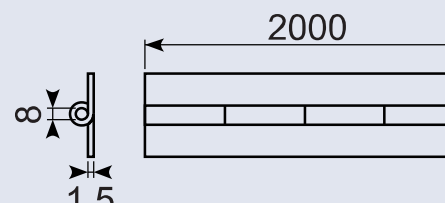

### 63.05310



Pianohængsel, rustfri  
Leveres i 2 m længder

0,8 x 30 mm

Piano hinge, stainless  
Supplied in 2 m length

63.05311

Pianohængsel, rustfri  
Leveres i 2 m længder

1,5 x 40 mm



Piano hinge, stainless  
Supplied in 2 m length

20.23233



Hængsel 3 mm plade.  
Rustfri - el-poleret

A: 60 mm  
B: 150 mm  
C: 125 mm  
D: 20 mm  
E: 60 mm  
F: 70 mm  
G: 45 mm  
H: 50 mm  
I: 30 mm  
J: 35 mm

Toolbox hinge  
Electropolished stainless steel 304

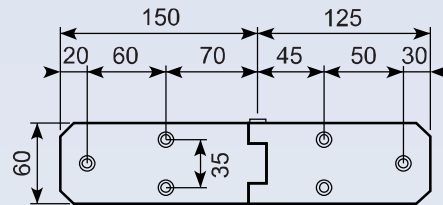

50.DL1120



Rustfri bladhængsel

Stainless hinge

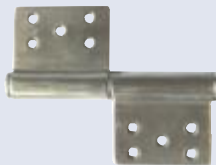

50.DL1130



Rustfri hængsel

Stainless hinge



50.DL1140



Rustfri hængsel f. værktøjskasser

Stainless hinge for toolbox



20.199SX



Rustfri hængsel

Hinge with M8 thread in short part, SS

113 + 138 mm  
Højde: 80 mm  
M8 gevind i kort part



50.9576-4



Varmtgalvaniseret hængsel  
Med messingtap, venstre

B: 40 mm  
H: 75 mm  
T: 2,5 mm

Hot dip hinge with brass pin, LH

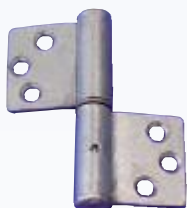

● Godt køb / best buy

20.2830



**Hængsel gulkrom**

53 x 50 x 1,5 mm

Hinge, yellow chrome

20.380

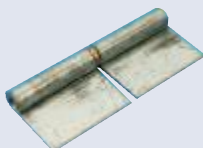

**Knop-hængsel uden huller  
Galvaniseret pladejern med messingdorn  
og skive.**

B: 42 mm  
L: 103 mm  
T: 3 mm

Weld-on hinge - no holes  
Mild steel plate, zinc-plated, brass pin

50.9748



**Galvaniseret hængsel med messingtap  
6 huller Ø5,3 mm**

63,5 x 44 x 1,6 mm

Zinc-plated hinge with brass pin  
6 holes Ø5,3 mm

20.05349A

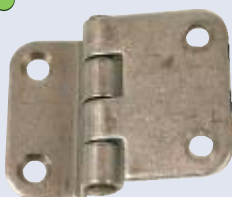

**Rustfri hængsel**

Bredde: 25 + 30 mm  
Højde: 40 mm

Stainless hinge

20.10256



**Messinghængsel. Forkromet.**

42 x 76 x 2 mm

Hinge, brass, nickel, chrome-plated D-031

20.1350



**Rudehængsel - fast  
Fiberforstærket PVC med kunststofstift  
og gummityld for 5 mm  
glasrude**

A: 80 mm  
B: 99 mm  
C: 50 mm  
D: 17,5 mm  
E: 44,5 mm  
F: 62 mm  
G: 22 mm  
H: 20 mm  
I: 8 mm  
J: 11 mm

PVC Hinge - fixed  
With pin made of synthetic material

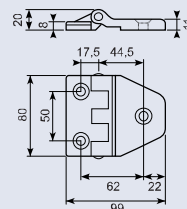

● Godt køb / best buy

20.1360



**Rudehængsel - fast**  
**Sortlakeret alloy med rustfri stift**  
**og gummipakning for 5 mm glasrude.**

Window/Hatch flat hinge  
 Black powder-coated with stainless steel pin  
 and rubber gasket.

A: 38 mm  
 B: 70 mm  
 C: 36 mm  
 D: 43 mm  
 E: 62 mm  
 F: 60 mm  
 G: 6 mm  
 H:  
 I: 18 mm  
 J: Ø6 mm

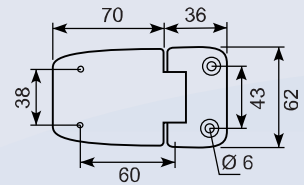

50.9751



**Hvid dørhængsel**

White door hinge

B: 27 x 16 x 13 mm  
 L: 80 mm

20.839



**Blokhængsel, krom, oplukkelig**  
**Til påboltning fra bagside**

Large block hinge  
 Chrome finish, plant-on fitting

A: 17 mm  
 B: 19 mm  
 C: 11 mm  
 D: 38 mm  
 E: 9 mm  
 F: 19 mm  
 G: Ø6 mm  
 H: Ø6 mm

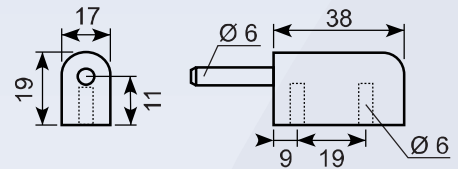

20.842



**Blokhængsel, krom**  
**Fast med skjulte skruer**

French hinge, chromium-plated  
 With concealed screws

A: 100 mm  
 B: 15 mm  
 C: 15 mm  
 D: 35 mm  
 E: 32 mm  
 F: 16 mm  
 G: 64 mm  
 H: 15 mm  
 I: Ø5 mm

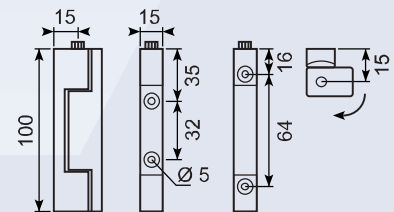

20.0541530

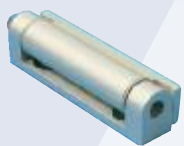

**Alu-blokhængsel. Fast med skjulte**  
**skruer.**

Block hinge, aluminium  
 With concealed screws

A: 70 mm  
 B: 62 mm  
 C: 42 mm  
 D: 16 mm  
 E: 14 mm  
 F: 19 mm  
 G: 14 mm  
 H: 19 mm

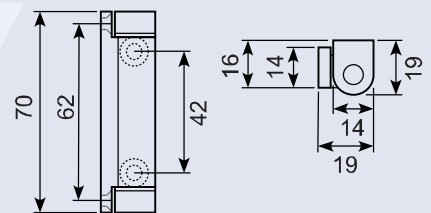

20.089



**Rustfri blokhængsel**  
**Oplukkelig, til påboltning fra bagside.**

Stainless block hinge  
 Opening, plant-on fitting

A: 19 mm  
 B: 13 mm  
 C: 13 mm  
 D: 38 mm  
 E: 19 mm  
 F: 9 mm  
 G: M6 mm  
 H: Ø6 mm

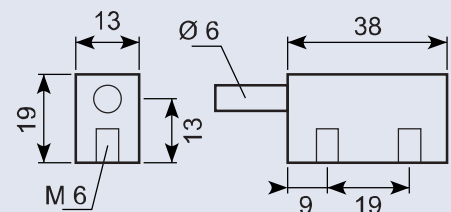

● Godt køb / best buy

## 20.090



### Fiberhængsel højre - løst Med rustfri stålstift. Til plan montage

Lift-off moulded hinge, RH  
Stainless steel pin.

A: 74 mm  
B: 30 mm  
C: 12 mm  
D: 18 mm  
E: 51 mm  
G: 20 mm  
F: Ø5 mm

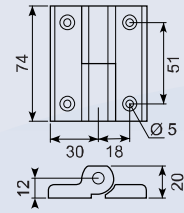

## 20.091



### Fiberhængsel venstre - løst Med rustfri stålstift. Til plan montage

Lift-off moulded hinge, LH  
Stainless steel pin.

A: 74 mm  
B: 30 mm  
C: 12 mm  
D: 18 mm  
E: 51 mm  
G: 20 mm  
F: Ø5 mm

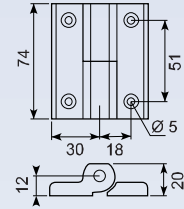

## 20.200



### Knophængsel - venstre Poleret rustfrit stål

Lift-off hinge - LH  
Polished stainless steel

A: 100 mm  
B: 37 mm  
C: 22,5 mm  
D: 60 mm  
E: Ø10 mm

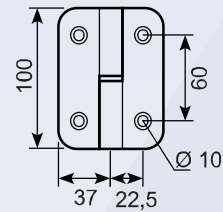

## 20.202



### Knophængsel - højre Poleret rustfrit stål

Lift-off hinge - RH  
Polished stainless steel

A: 100 mm  
B: 37 mm  
C: 22,5 mm  
D: 60 mm  
E: Ø10 mm

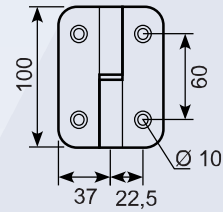

## 20.203R



### Knophængsel - venstre Poleret rustfrit stål med aflange huller

Lift-off hinge - LH  
Polished stainless steel, elongated holes

A: 100 mm  
B: 37 mm  
D: 22,5 mm  
E: 60 mm

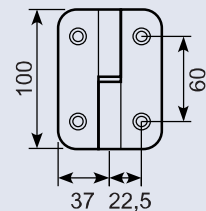

## 20.204R



### Knophængsel - højre Poleret rustfrit stål med aflange huller

Lift-off hinge - RH  
Polished stainless steel, elongated holes

A: 100 mm  
B: 37 mm  
D: 22,5 mm  
E: 60 mm

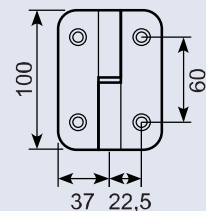

## 20.209R



### Fast hængsel Poleret rustfrit stål med aflange huller

Fixed-pin vertical leaf hinge  
Polished stainless steel, elongated holes

A: 130 mm  
B: 39 mm  
C: 15 mm  
D: 22,5 mm  
E: 94 mm  
F: Ø10 mm

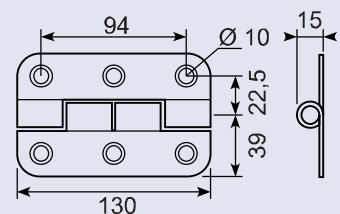



63.05250



**Hængsel, rustfri**  
**Særdeles eksklusiv finish**  
**Håndpoleret**  
**Større holdbarhed/stærkere**  
**Mindre slør**

38 x 37 mm

Hinge, stainless steel  
Exclusive finish, hand-polished  
Durable/strong, small clearance

63.05255



**Hængsel rustfri**  
**Særdeles eksklusiv finish**  
**Håndpoleret**  
**Større holdbarhed/stærkere**  
**Mindre slør**

36 x 48 mm

Hinge, stainless steel  
Exclusive finish, hand-polished  
Durable/strong, small clearance

63.05260



**Hængsel rustfri**  
**Særdeles eksklusiv finish**  
**Håndpoleret**  
**Større holdbarhed/stærkere**  
**Mindre slør**

38 x 59 mm

Hinge, stainless steel  
Exclusive finish, hand-polished  
More durable/stronger  
Smaller clearance  
38 x 59 mm

63.05261



**Hængsel, rustfri**  
**Særdeles eksklusiv finish**  
**Håndpoleret**  
**Større holdbarhed/stærkere**  
**Mindre slør**

38 x 76 mm

Hinge, stainless steel  
Exclusive finish, hand-polished  
More durable/stronger  
Smaller clearance  
38 x 76 mm

63.05264



**Hængsel, rustfri**  
**Særdeles eksklusiv finish**  
**Håndpoleret**  
**Større holdbarhed/stærkere**  
**Mindre slør**

38 x 76 mm

Hinge, stainless steel  
Exclusive finish, hand-polished  
More durable/stronger  
Smaller clearance  
38 x 76 mm

63.05270



**Hængsel, rustfri**  
**Særdeles eksklusiv finish**  
**Håndpoleret**  
**Større holdbarhed/stærkere**  
**Mindre slør**

38 x 67 mm

Hinge, stainless steel  
Exclusive finish, hand-polished  
More durable/stronger  
Smaller clearance  
38 x 67 mm

63.05271



**Hængsel, rustfri**  
**Særdeles eksklusiv finish**  
**Håndpoleret**  
**Større holdbarhed/stærkere**  
**Mindre slør**

27 x 104 mm

Hinge, stainless steel  
Exclusive finish, hand-polished  
More durable/stronger  
Smaller clearance  
27 x 104 mm

63.05273



**Hængsel, rustfri**  
**Særdeles eksklusiv finish**  
**Håndpoleret**  
**Større holdbarhed/stærkere**  
**Mindre slør**

26 x 154 mm

Hinge, stainless steel  
Exclusive finish, hand-polished  
More durable/stronger  
Smaller clearance  
26 x 154 mm

63.05275



**Hængsel, rustfri**  
**Særdeles eksklusiv finish**  
**Håndpoleret**  
**Større holdbarhed/stærkere**  
**Mindre slør**

38 x 74 mm

Hinge, stainless steel  
Exclusive finish, hand-polished  
More durable/stronger  
Smaller clearance  
38 x 74 mm

63.05277



**Hængsel, rustfri**  
**Særdeles eksklusiv finish**  
**Håndpoleret**  
**Større holdbarhed/stærkere**  
**Mindre slør**

38 x 108 mm

Hinge, stainless steel  
Exclusive finish, hand-polished  
More durable/stronger  
Smaller clearance  
38 x 108 mm

63.05279



**Hængsel, rustfri**  
**Særdeles eksklusiv finish**  
**Håndpoleret**  
**Større holdbarhed/stærkere**  
**Mindre slør**

38 x 142 mm

Hinge, stainless steel  
Exclusive finish, hand-polished  
More durable/stronger  
Smaller clearance  
38 x 142 mm

63.05281



**Bordhængsel til nedfældning**  
**Særdeles eksklusiv finish**  
**Håndpoleret**  
**Større holdbarhed/stærkere**  
**Mindre slør**

41 x 70 mm

Hinge, stainless steel  
Exclusive finish, hand-polished  
More durable/stronger  
Smaller clearance  
41 x 70 mm

63.05300



**Bladhængsel/RF pianohængsel**  
**Messing**

30 x 52 mm

Piano hinge, brass

63.05301

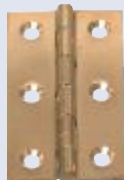

**Bladhængsel/RF pianohængsel**  
**Messing**

35 x 65 mm

Piano hinge, brass

63.05302



**Bladhængsel/RF pianohængsel**  
**Messing**

41 x 77 mm

Piano hinge, brass

63.05303



**Bladhængsel/RF pianohængsel**  
**Krom**

30 x 52 mm

Piano hinge, chrome

63.05304



**Bladhængsel/RF pianohængsel  
Krom**

35 x 65 mm

Piano hinge, chrome

63.05305



**Bladhængsel/RF pianohængsel  
Krom**

41 x 77 mm

Piano hinge, chrome

63.05315



**Dørhængsel, rustfri  
Særdeles eksklusiv finish  
Håndpøleret  
Større holdbarhed/stærkere  
Mindre slør**

37 x 37 mm

Hinge, stainless steel  
Exclusive finish, hand-polished  
More durable/stronger  
Smaller clearance  
37 x 37 mm

63.05316



**Dørhængsel, rustfri  
Særdeles eksklusiv finish  
Håndpøleret  
Større holdbarhed/stærkere  
Mindre slør**

37 x 37 mm

Hinge, stainless steel  
Exclusive finish, hand-polished  
More durable/stronger  
Smaller clearance  
37 x 37 mm

63.05320



**Overfaldshængsel, messing  
Hjre - 52 mm lang**

Hinge, brass, RH  
Length 52 mm

63.05321

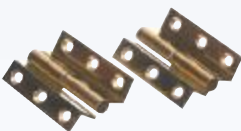

**Overfaldshængsel, messing  
Venstre - 52 mm lang**

Hinge, brass, LH  
Length 52 mm

63.05325



**Overfaldshængsel, krom  
Højre - 52 mm lang**

Hinge, chrome, RH  
Length 52 mm

63.05326



**Overfaldshængsel, krom  
Venstre - 52 mm lang**

Hinge, chrome, LH  
Length 52 mm

63.05340



**Højglanspoleret hængsel  
316 rustfri, syrefast stål.  
Lever op til den bedste kvalitet  
på markedet. Tykkelse 2 mm.**

Highly polished hinge  
316 stainless, acidproof steel  
2 mm thick

A: 21 mm  
B: 14 mm  
39 x 38 mm

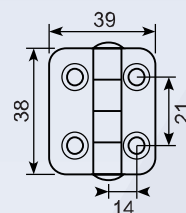

63.05341



**Højglanspoleret hængsel  
316 rustfri syrefast stål  
Lever op til den bedste kvalitet  
på markedet. Tykkelse 2 mm**

Highly polished hinge  
316 stainless, acidproof steel  
2 mm thick

A: 21 mm  
B: 11 mm  
C: 18 mm  
D: 14 mm  
56 x 38 mm

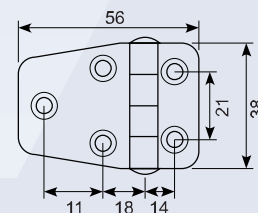

63.05342



**Højglanspoleret hængsel  
316 rustfri syrefast stål  
Lever op til den bedste kvalitet på  
markedet. Tykkelse 2 mm.**

Highly polished hinge  
316 stainless, acidproof steel  
2 mm thick.

A: 35 mm  
B: 24 mm  
C: 17 mm  
D: 12 mm  
72 x 38 mm

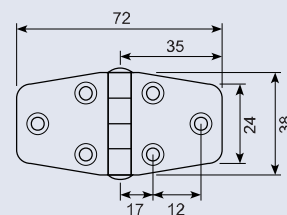

63.05343



**Højglanspoleret hængsel  
316 rustfri syrefast stål  
Lever op til den bedste kvalitet  
på markedet. Tykkelse 2 mm**

Highly polished hinge  
316 stainless, acidproof steel  
2 mm thick

A: 23 mm  
B: 19 mm  
46 x 37 mm

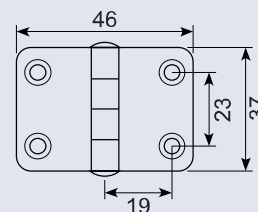

63.05344



**Højglanspoleret hængsel**  
**316 rustfri syrefast stål**  
**Lever op til den bedste kvalitet på**  
**markedet. Tykkelse 2 mm.**

Highly polished hinge  
 316 stainless, acidproof steel  
 2 mm thick

A: 20 mm  
 B: 18 mm  
 C: 18 mm  
 D: 34 mm  
 95 x 39 mm

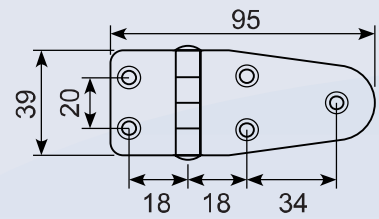

63.05345



**Højglanspoleret hængsel**  
**316 rustfri syrefast stål**  
**Lever op til den bedste kvalitet på**  
**markedet. Tykkelse 2 mm.**

Highly polished hinge  
 316 stainless, acidproof steel  
 2 mm thick.

A: 20 mm  
 B: 18 mm  
 70 x 39 mm

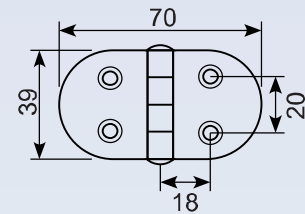

63.05346



**Højglanspoleret hængsel**  
**316 rustfri syrefast stål**  
**Lever op til den bedste kvalitet på**  
**markedet. Tykkelse 2 mm.**

Highly polished hinge  
 316 stainless, acidproof steel  
 2 mm thick

A: 20 mm  
 B: 34 mm  
 C: 18 mm  
 104 x 39 mm

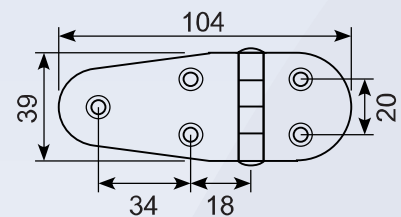

63.05347



**Højglanspoleret hængsel**  
**316 rustfri syrefast stål**  
**Lever op til den bedste kvalitet på**  
**markedet. Tykkelse 2 mm.**

Highly polished hinge  
 316 stainless, acidproof steel  
 2 mm thick

A: 21 mm  
 B: 35 mm  
 C: 18 mm  
 136 x 39 mm

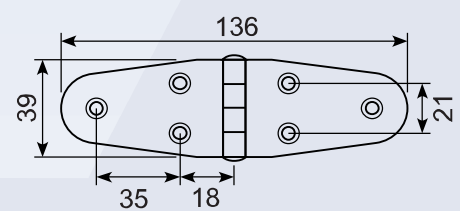

63.05348



**Højglanspoleret hængsel**  
**316 rustfri syrefast stål**  
**Lever op til den bedste kvalitet på**  
**markedet. Tykkelse 2 mm.**

Highly polished hinge  
 316 stainless, acidproof steel  
 2 mm thick

A: 27 mm  
 B: 14 mm  
 C: 17 mm  
 74 x 40 mm

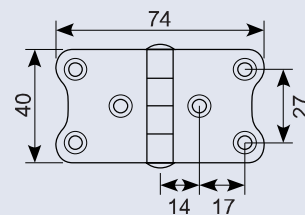

63.05349



**Højglanspoleret hængsel**  
**316 rustfri syrefast stål**  
**Lever op til den bedste kvalitet**  
**på markedet. Tykkelse 2mm.**

Highly polished hinge  
 316 stainless, acidproof steel  
 2 mm thick.

A: 27 mm  
 B: 17 mm  
 C: 14 mm  
 D: 18 mm  
 E: 28 mm  
 F: 35 mm  
 130 x 40 mm

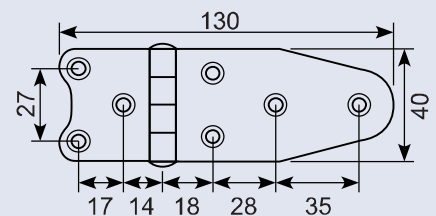

63.05350



**Højglanspoleret hængsel**  
**316 rustfri syrefast stål.**  
**Lever op til den bedste kvalitet på**  
**markedet. Tykkelse 2 mm.**

Highly polished hinge  
 316 stainless, acidproof steel  
 2 mm thick

A: 27 mm  
 B: 18 mm  
 C: 28 mm  
 D: 35 mm  
 180 x 40 mm

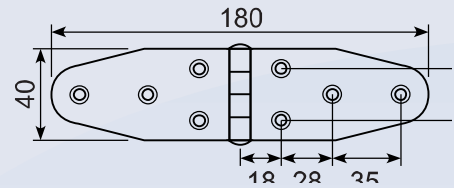

63.05351

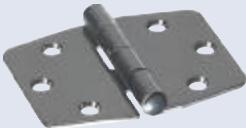

**Højglanspoleret hængsel**  
**316 rustfri syrefast stål**  
**Lever op til den bedste kvalitet på**  
**markedet. Tykkelse 2 mm.**

Highly polished hinge  
 316 stainless, acidproof steel  
 2 mm thick

A: 38 mm  
 B: 40 mm  
 C: 22 mm  
 74 x 60 mm

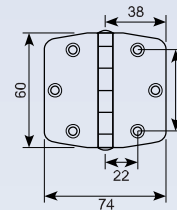

63.05352



**Højglanspoleret hængsel**  
**316 rustfri syrefast stål.**  
**Lever op til den bedste kvalitet på**  
**markedet. Tykkelse 2 mm.**

Highly polished hinge  
 316 stainless, acidproof steel.  
 2 mm thick.

A: 55 mm  
 B: 21 mm  
 C: 32 mm  
 73 x 75 mm

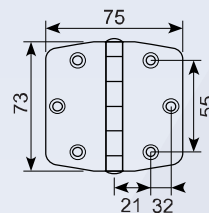

63.05353

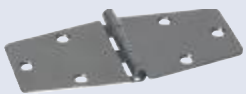

**Højglanspoleret hængsel**  
**316 rustfri syrefast stål**  
**Lever op til den bedste kvalitet på**  
**markedet. Tykkelse 2 mm.**

Highly polished hinge  
 316 stainless, acidproof steel  
 2 mm thick

A: 74 mm  
 B: 36 mm  
 C: 29 mm  
 151 x 75 mm

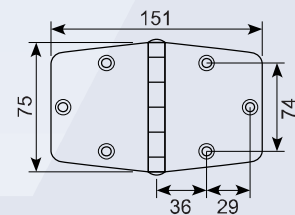

63.05354



**Højglanspoleret hængsel**  
**316 rustfri syrefast stål.**  
**Lever op til den bedste kvalitet på**  
**markedet. Tykkelse 2 mm.**

Highly polished hinge  
 316 stainless, acidproof steel  
 2 mm thick

A: 51 mm  
 B: 16 mm  
 C: 24 mm  
 103 x 28 mm

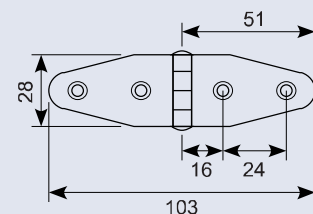

63.05355



**Højglanspoleret hængsel**  
**316 rustfri syrefast stål.**  
**Lever op til den bedste kvalitet på**  
**markedet. Tykkelse 2 mm.**

Highly polished hinge  
 316 stainless, acidproof steel  
 2 mm thick

A: 77 mm  
 B: 51 mm  
 C: 26 mm  
 D: 26 mm  
 E: 18 mm  
 F: 16 mm  
 G: 24 mm  
 230 x 28 mm

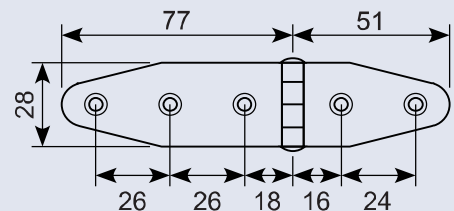

63.05356



**Højglanspoleret hængsel**  
**316 rustfri syrefast stål**  
**Lever op til den bedste kvalitet på**  
**markedet. Tykkelse 2 mm.**

Highly polished hinge  
 316 stainless, acidproof steel  
 2 mm thick

A: 77 mm  
 B: 26 mm  
 C: 26 mm  
 D: 18 mm  
 103 x 28 mm

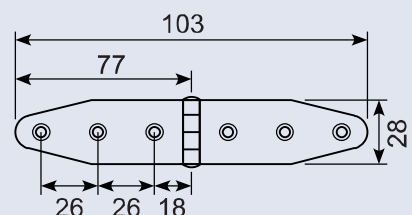

63.05357



**Højglanspoleret hængsel**  
**316 rustfri syrefast stål.**  
**Lever op til den bedste kvalitet**  
**på markedet. Tykkelse 2 mm**  
**Til nedfældning**

Highly polished hinge  
 316 stainless, acidproof steel  
 2 mm thick

A: 26 mm  
 B: 19 mm  
 C: 14 mm  
 38 x 76 mm

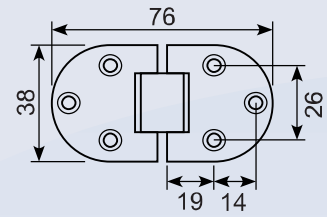

63.05358



**Højglanspoleret hængsel**  
**316 rustfri syrefast stål.**  
**Lever op til den bedste kvalitet**  
**på markedet. Tykkelse 2 mm.**

Highly polished hinge  
 316 stainless, acidproof steel  
 2 mm thick

A: 21 mm  
 35 x 37 mm  
 Forskudt 10 mm

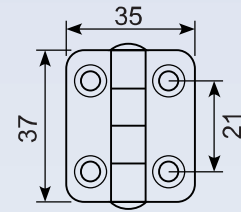

63.05359



**Højglanspoleret hængsel**  
**316 rustfri syrefast stål.**  
**Lever op til den bedste kvalitet**  
**på markedet. Tykkelse 2 mm.**

Highly polished hinge  
 316 stainless, acidproof steel  
 2 mm thick

A: 24 mm  
 B: 21 mm  
 C: 11 mm  
 D: 9 mm  
 48 x 30 mm

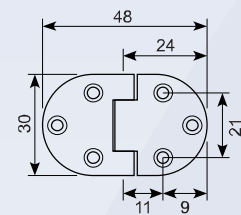

63.05360



**Højglanspoleret hængsel**  
**316 rustfri syrefast stål.**  
**Lever op til den bedste kvalitet**  
**på markedet. Tykkelse 2 mm.**

Highly polished hinge  
 316 stainless, acidproof steel  
 2 mm thick

A: 22 mm  
 B: 22 mm  
 C: 30 mm  
 D: 11 mm  
 64 x 38 mm  
 Forskudt 10 mm

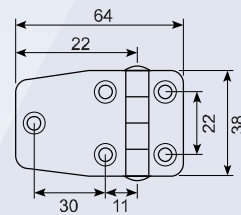

63.05361



**Højglanspoleret hængsel**  
**316 rustfri syrefast stål**  
**Lever op til den bedste kvalitet**  
**på markedet. Tykkelse 2 mm.**

Highly polished hinge  
 316 stainless, acidproof steel  
 2 mm thick

A: 16 mm  
 B: 30 mm  
 C: 10 mm  
 70 x 51 mm  
 Forskudt 10 mm

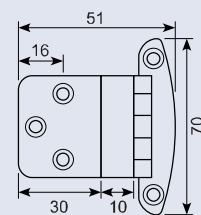



## Stanglåse og indbygningslukker / Rod latches and paddle locks

### 50.DL2120

**Rustfri indbygningslukker, incl. top og bundstykke. Ø15 mm**

Stainless paddle lock incl. top and bottom part. Ø15 mm

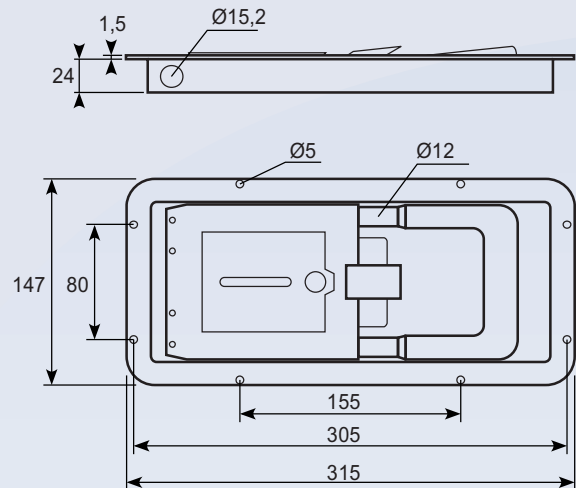
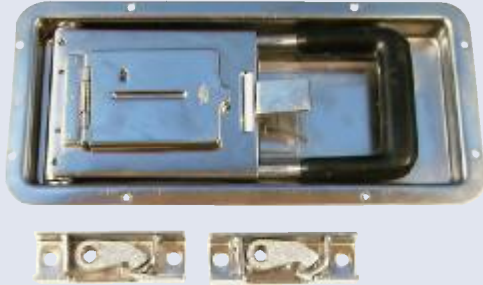

### 54.200100

**Stanglås til 15 mm rør  
Rustfri - ens nøgler**

Stainless lock for 15 mm tube  
Identical keys

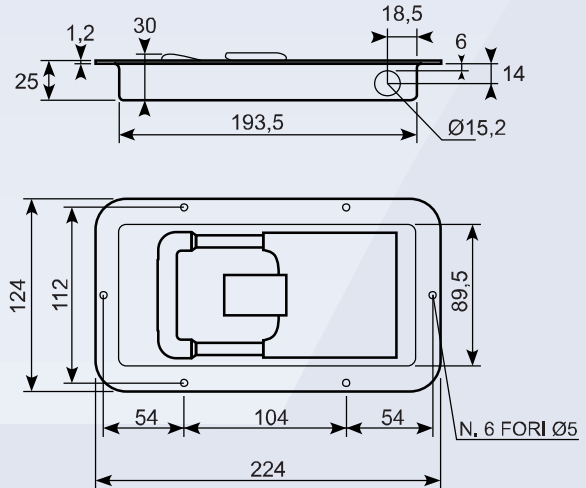

### 50.DL2130

**Rustfri indbygningslukker, incl. top og bundstykke Ø15 mm.**

Stainless paddle lock incl. top and bottom part, totally 2 sets. Ø15 mm.

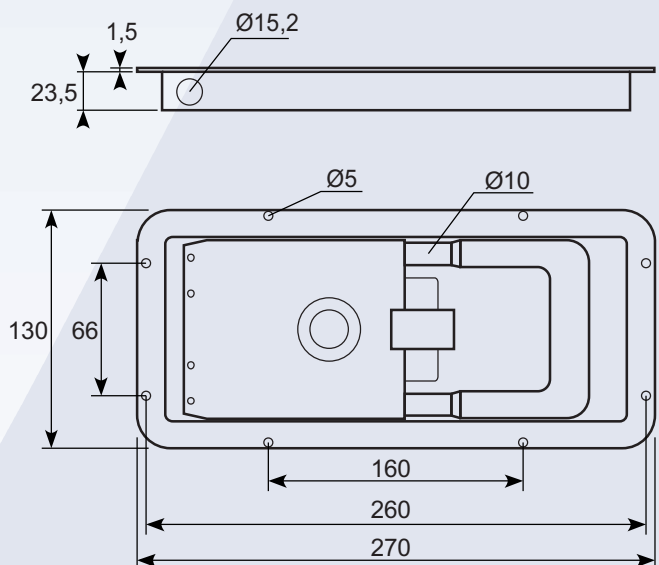

● Godt køb / best buy

## 54.200900

### Stanglås til 16 mm rør Rustfri - ens nøgler

Stainless lock for 16 mm tube  
Identical keys

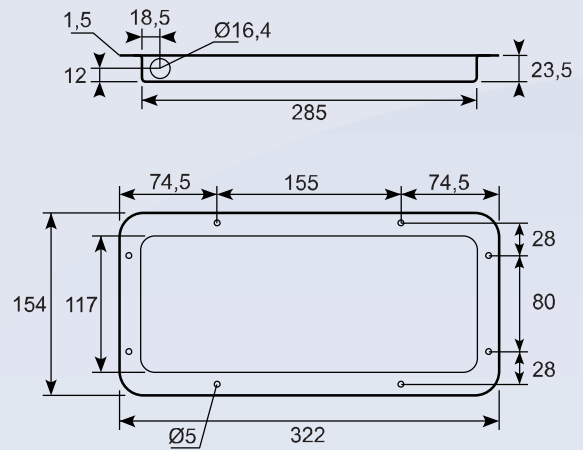

## 50.DL5081



### Rustfri fodplade. Passer til 50.DL5082.

Stainless foot plate / keeper



A: 100 mm  
B: 26 mm  
C: 78 mm  
D: Ø8,5 mm

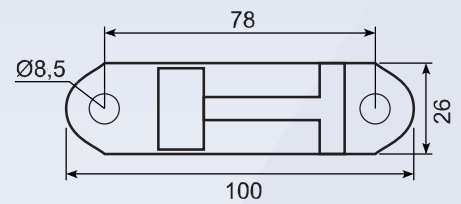

## 50.DL5082



### Rustfri griber. Passer til 50.DL5081.

Stainless hook / cam



A: 28 mm  
B: 16,5 mm

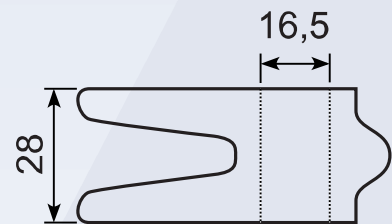

## 50.DL2050SS



### Lås, rustfri Ø22 mm m. 2 nøgler

Stainless door lock Ø22 mm with 2 keys.  
Different key combinations.

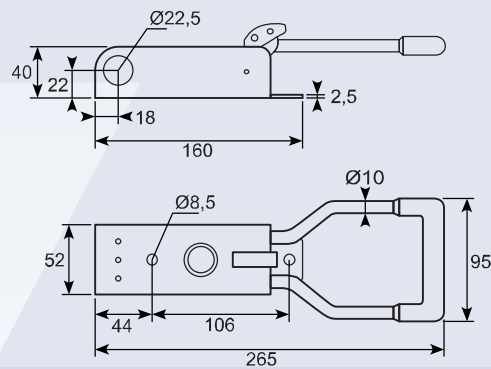

## 50.DL2020



### Udenpåliggende rustfri stanglås. Ø22 mm.

Stainless fastener Ø22 mm

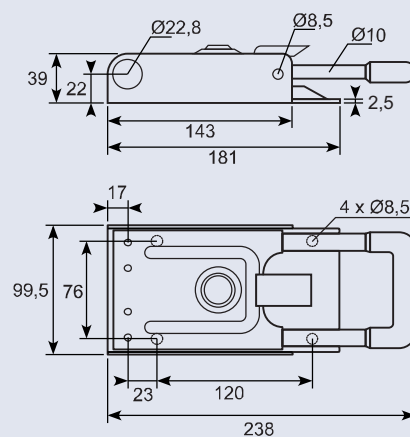

● Godt køb / best buy

### 50.DL5051SS



Rustfri fodstykke m. 2 huller  
Passer til griber 50.DL5071SS



Stainless keeper with 2 holes.

### 50.DL5071SS



Rustfri griber til påsvejsning. Kort model.  
Tap ca 17,5 mm. Til Ø22 mm rør.  
Passer til fodstykke 50.DL5051SS.



Stainless cam for welding. Short model.

### 50.DL5061



Rustfri griber til påsvejsning, lang model.  
Passer til fodstykke 50.DL5051SS

Stainless cam for welding, long model.

A: 162 mm  
B: 17 mm  
C: 114 mm  
D: 31 mm

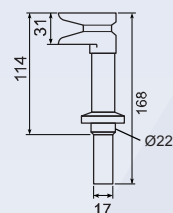

### 50.DL3030SS



Rustfri spændecamp. Passer til  
50.DL3070, Ø22 mm indsats og  
50.DL3060, Ø27 mm indsats.

Stainless tube clamp/pipe retainer



### 50.DL3070



Ø22 mm PVC indsats til spændecamp.  
Passer til spændecamp 50.DL3030SS.

PVC insert for 22 mm, fits 3030.

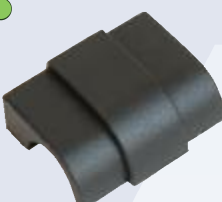

### 50.DL3050



PVC Ø22 mm indsats til spændecamp.  
Passer til lang spændecamp 50.DL3010.

PVC insert



### 50.DL2040

- Udenpåliggende rustfri stanglås, Ø27 mm.

Stainless fastener Ø27 mm

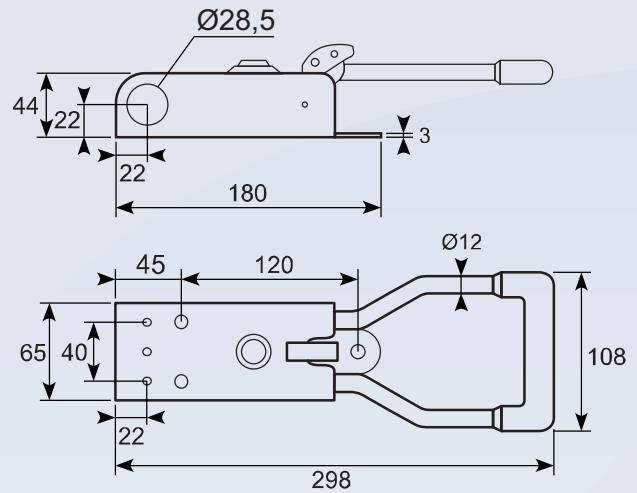
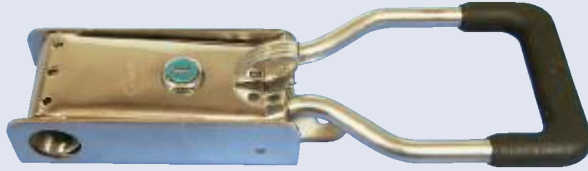

### 50.DL2010

- Udenpåliggende Ø27 mm rustfri stanglås.

Stainless fastener Ø27 mm

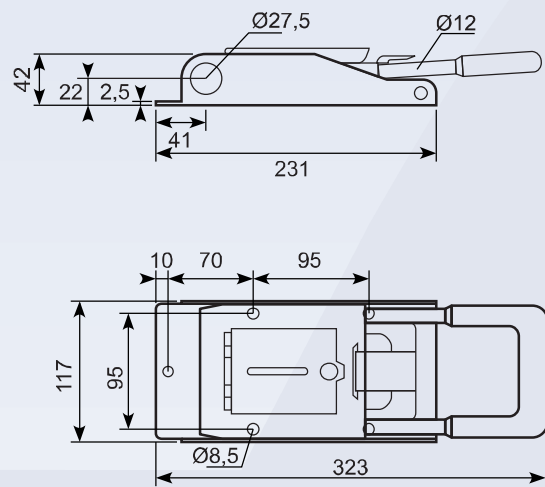

### 50.dl5051

Rustfri fodstykke med 2 huller. Passer til spændetop 50.DL5052.

Stainless baseplate

### 50.DL5052

- Rustfri griber, kort model. Passer til fodstykke 50.DL5051.

Stainless hook / cam



A: 78 mm  
B: 21 mm  
C: 47 mm  
D: 31 mm

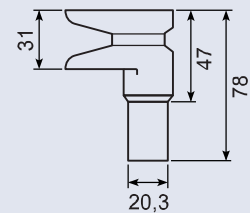

### 50.DL5031

- Rustfri fodplade. Passer til griber 50.DL5032.

Stainless baseplate / keeper.



A: 130 mm  
B: 28 mm  
C: 112 mm  
D: Ø10,5 mm

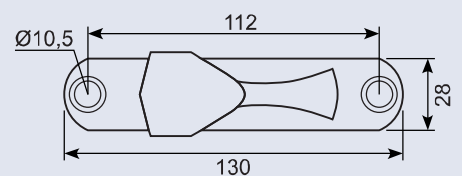

- Godt køb / best buy

### 50.DL5032



Rustfri griber, lang model. Passer til fodstykke 50.DL5031.

Stainless hook / cam-bng

A: 176 mm  
B: 146 mm  
C: 47 mm  
D: 21 mm

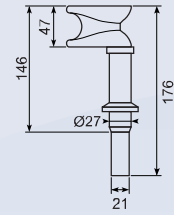

### 50.DL3060



Ø27 mm PVC indsats. Passer til spændecamp 50.DL3030SS.

PVC insert

### 50.DL3040



Ø27 mm PVC indsats, lang model. Passer til spændecamp 50.DL3010.

PVC insert

### 50.DL3010

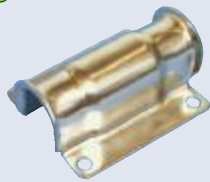

Rustfri spændecamp, lang model. Passer til 50.DL3050, Ø22 mm indsats og 50.DL3040, Ø27 mm indsats.

Stainless clamp for fastening

A: 104 mm  
B: 80 mm  
C: 81 mm  
D: 63 mm

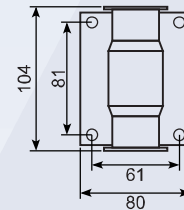

### 50.DL3020

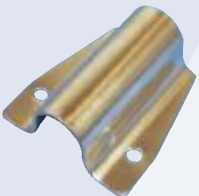

Rustfri spændecamp til Ø27 mm rør - direkte montering. Bruges ofte over lås.

Stainless clamp for fastening

A: 90 mm  
B: 84 mm  
C: 63 mm  
D: 24 mm  
E: 3 mm  
F: Ø8,5 mm

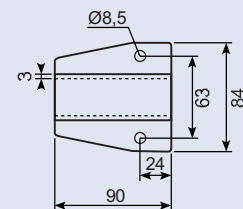

### 50.DL5011



Rustfri fodplade. Heavy duty. Passer til kort griber 50.DL5021 og lang griber 50.DL5012.

Stainless baseplate

A: 134 mm  
B: 108 mm  
C: Ø10,5 mm

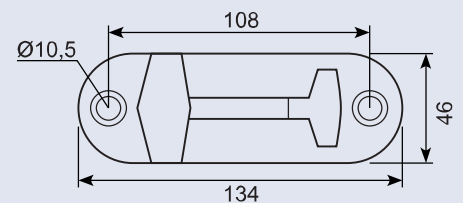

### 50.DL5012



Rustfri griber. Heavy duty. Lang model. Passer til fodstykke 50.DL5011.

Stainless hook

A: 197 mm  
B: 147 mm  
C: 48 mm  
D: Ø21 mm

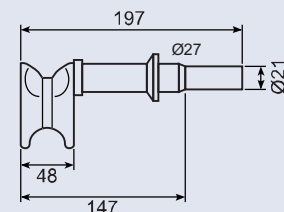

● Godt køb / best buy

### 50.DL5021



Rustfri griber. Heavy duty. Kort model.  
Passer til fodstykke 50.DL5011.

Stainless hook

A: 100 mm  
B: 74 mm  
C: 48 mm  
D: Ø21 mm

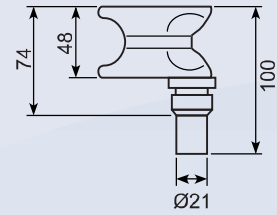

### 50.DL2080



Rustfri håndtag Ø27 mm

Stainless handle Ø27 mm

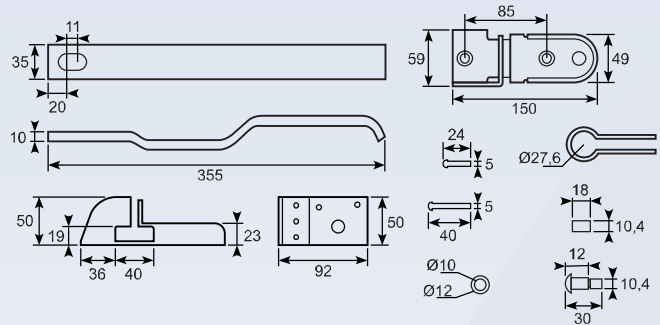

### 50.DL2110



Rustfri lukker Ø27 mm

Stainless fastener Ø27 mm

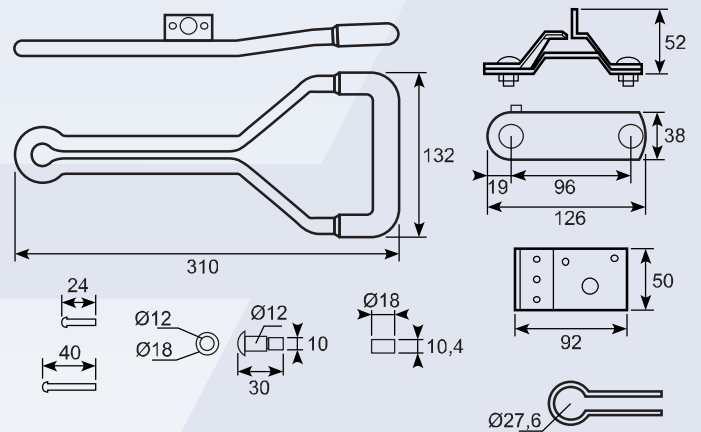
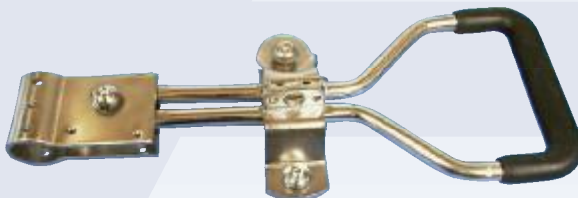

### 50.DL2090



Rustfri lukker til påsvejsning.

Stainless fastener

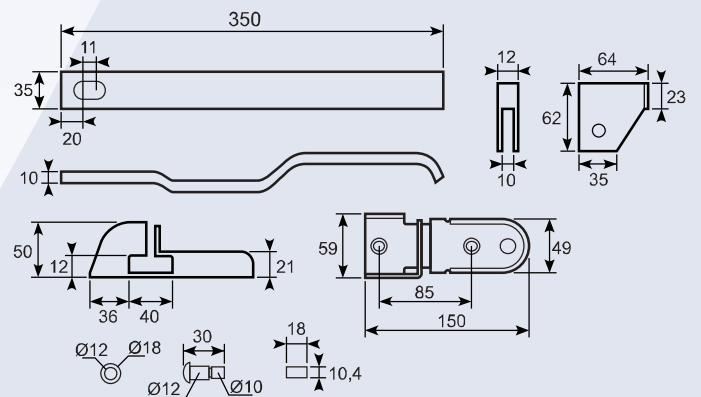

● Godt køb / best buy

## 54.9648



**Stanghængsel Ø27 mm, galvaniseret**  
Leveres med: 2 stk. endebeslag, 4 stk.  
føringer, håndtag, beslag for aflåsning  
Rør medleveres ikke

19 mm rod lock, zinc-plated

## Stanglås oversigt

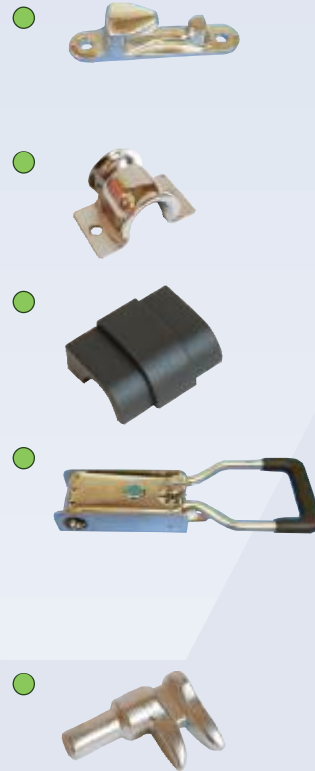
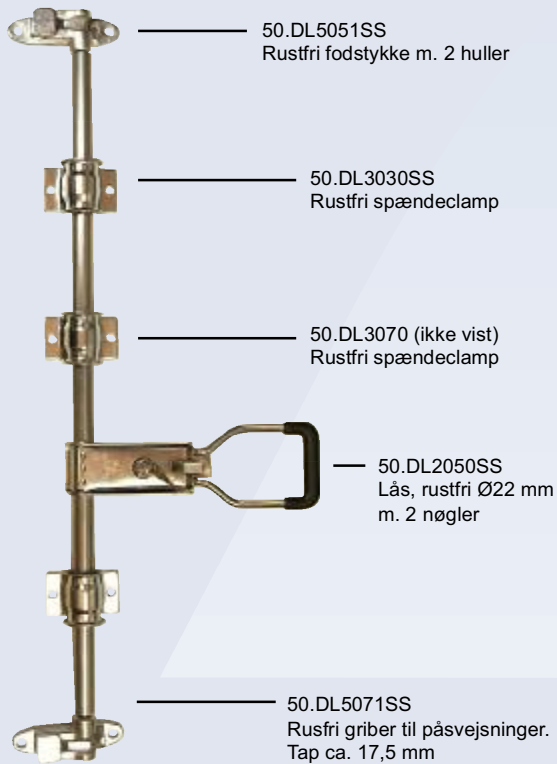

## 50.DL2140



### Rustfri indbygningslukker

Stainless paddle lock

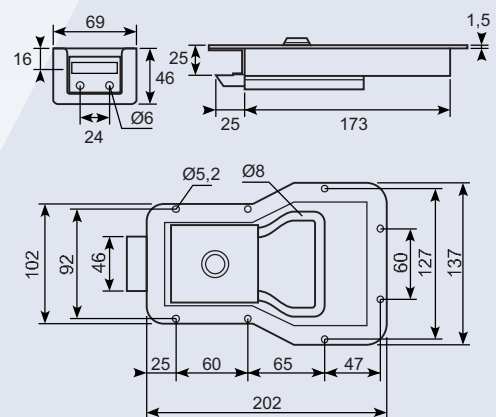

## 50.120JX



**Galvaniseret hægtelukker i skål med løs  
bagplade og flad sikkerheds-lås**

Zinc-plated hook lock in bowl with back plate  
and with new safety lock

Bredde: 123 x 73  
mm  
Længde: 280 mm



Godt køb / best buy



## 50.121JX



**Galvaniseret hægtelukker med sikkerhedspal, uden bagplade**

73 x 140 mm  
43 x 230 mm



Zinc-plated hook lock with new safety catch, without back plate

## 50.9239



**Galvaniseret trailerlukker**

Zinc-plated trailer lock



## 50.1023J



**galvaniseret hægtelukker m. fjederpal.**

Fastener with spring catch, zinc-plated



## 50.10626



**Smedet excenterlukker galvaniseret med indst. øje med sikkerhedslås og kort greb.**

Eccentric lock, forges, zinc-plated with adjustable eye, safety lock and short handle



## 50.15794



**Containerlukker. Indstillelig øje.**

Side board latch with safety device and adjustable eye



## 50.15795X



**Galvaniseret holdekrog til 50.15794**

Hook for welding-on for item 50.15795, zinc-plated



## 50.140

**K-jern til påsvejsning 45°  
Rå**

Buckled iron for welding-on 45 degr., raw

A: 19 mm  
B: 15 mm  
C: 6 mm  
D: 30 mm

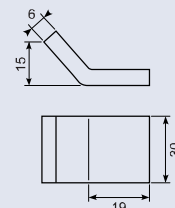
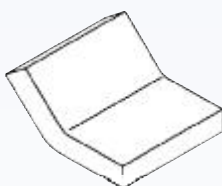

Godt køb / best buy



### 50.10251

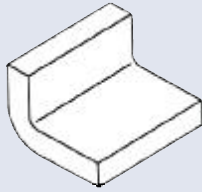

#### K-jern til påsvejsning 90° Rå

Buckled iron 90 degr. for welding-on 30 mm, raw

A: 25 mm  
B: 18 mm  
C: 6 mm  
D: 30 mm

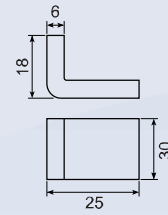

### 50.1028



#### K-jern til påsvejsning 100 mm, rå.

Buckled iron for welding-on 100 mm, raw

### 50.0108

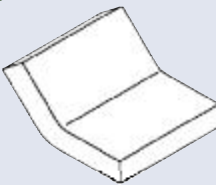

#### K-jern til påsvejsning 45° Rå

K-iron for welding-on 45° bend, raw

A: 10 mm  
B: 10 mm  
C: 5 mm  
D: 30 mm

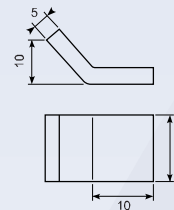

### 50.9000001

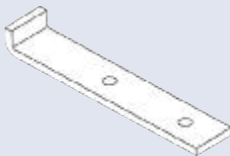

#### K-jern til påskruening - Lige Rå

Buckled iron for fastening, 90 degr., black

A: 140 mm  
B: 30 mm  
C: 46 mm  
D: 23,5 mm  
E: 18 mm  
F: 6 mm  
G: Ø8,5 mm

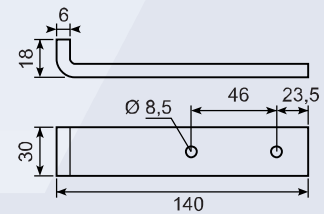

### 50.0116



#### K-jern til påsvejsning. Rå.

K-iron model 0116 for welding-on for closer in bowl 50.120J, raw

### 50.143H

#### K-jern til påskruening - forkrøppet Galvaniseret, højre

Buckled iron for screwing, cranked, zinc-plated, right model



### 50.143V

#### K-jern til påskruening - forkrøppet Galvaniseret, venstre.

Buckled iron for screwing, cranked, zinc-plated, left model



● Godt køb / best buy

50.900002J

Galvaniseret modhold med buk, 2 huller 140 mm

Zinc-plated catcher with support, 2 holes



50.32687

Alu. hængsel, komplet

Aluminium hinge, complete

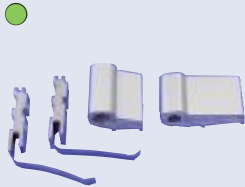

54.070103132

Dørhængsel, rustfri

Stainless door hinge

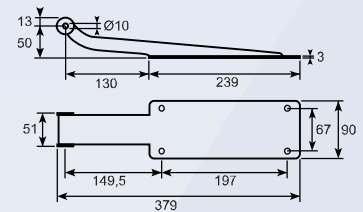

54.070103133

Dørhængsel, galvaniseret

Zinc-plated door hinge

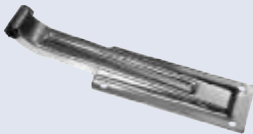

54.070203104

Dørhængsel, galvaniseret

Zinc-plated door hinge

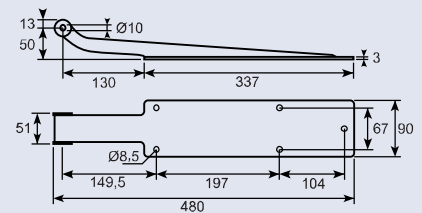

54.070322202

Hængselryg, rustfri

Stainless hinge bracket

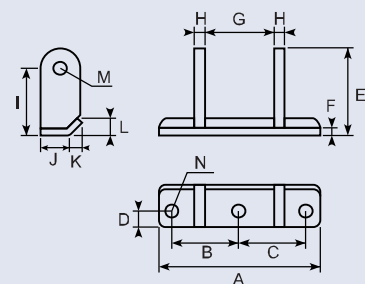
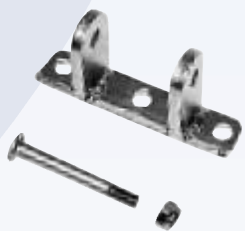

54.070422219

Hængselryg, galvaniseret

Zinc-plated hinge bracket

● Godt køb / best buy

54.070822017

Sidedørshængsel, forkrøppet 207 mm.  
Rustfri

Stainless side door hinge, cranked, 207 mm

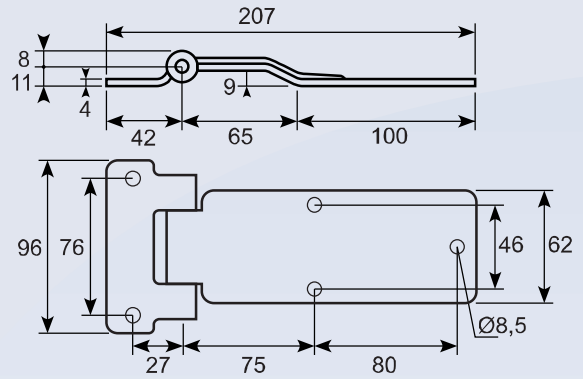

54.220800

Sidedørshængsel, forkrøppet.  
Galvaniseret

Zinc-plated side door hinge, cranked



20.210JX

Bladhængsel/forkrøppet  
Poleret rustfrit stål

Hinge  
Polished stainless steel

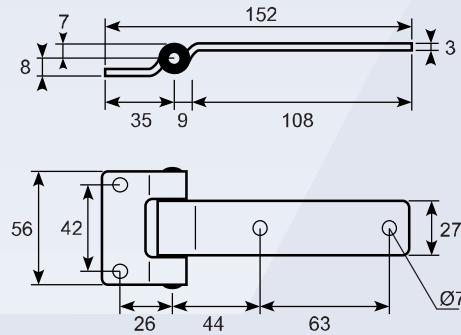

20.211

Bladhængsel  
Poleret rustfrit stål

Hinge  
Polished stainless steel



A: 42 mm  
B: 132 mm  
C: 62 mm  
D: 96 mm

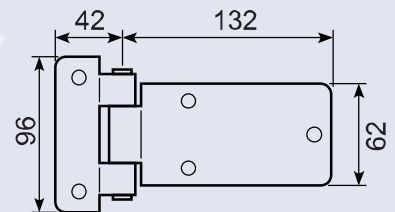

20.212

Bladhængsel  
Poleret rustfrit stål

Door hinge  
Polished stainless steel

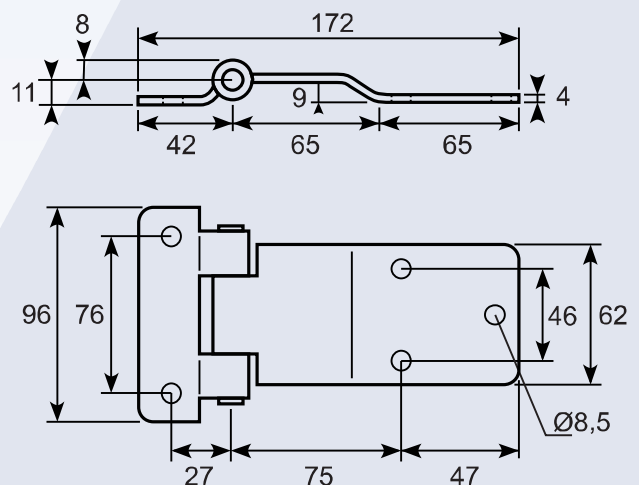
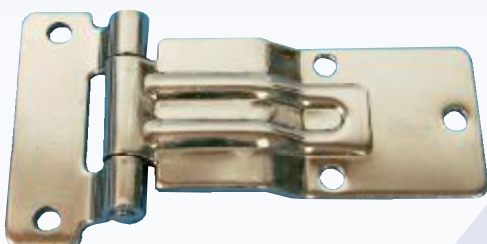

● Godt køb / best buy

## 20.213



### Bladhængsel Poleret rustfrit stål

40 x 95/42 mm  
H: 34 mm



Stainless rocca hinge  
Electro polished

## 20.216J



### Sidedørshængsel 180°, rustfri. Godstykkelse 2,5 mm

Stainless hinge  
Polished

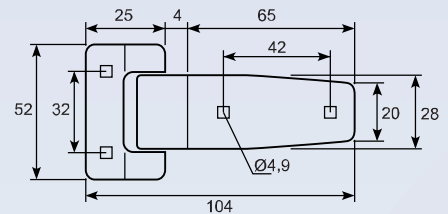

## 20.218G

### Bladhængsel med smørenippel. Galvaniseret.

Door hinge with grease nipple  
Zinc-plated

A: 105 mm  
B: 68 mm  
C: 56 mm  
D: 180 mm  
E: 5 mm  
F: Ø10 mm

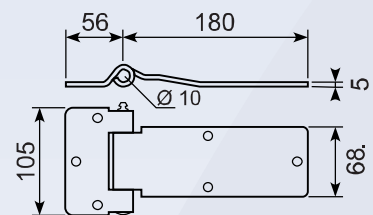
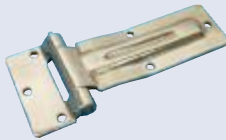

## 50.013020



### Sidedørshængsel m. smørenippel Galvaniseret

71 x 116 mm  
Bredde: 65 mm

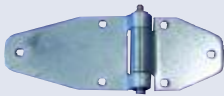

Side door hinge, zinc-plated with lubricating nipple

## 50.013020S



### Sidedørshængsel m. smørenippel Rustfri

71 x 116 mm  
Bredde: 65 mm



Side door nipple, SS  
With lubricating nipple

## 50.013030



### Sidedørshængsel m. smørenippel Galvaniseret

33 x 116 mm  
Bredde: 65 mm



Side door hinge, zinc-plated  
With lubricating nipple

## 50.013030S



### Sidedørshængsel m. smørenippel Rustfri

33 x 116 mm  
Bredde: 65 mm



Side door hinge, SS  
With lubricating nipple

Godt køb / best buy

### 50.013060



#### Sidedørshængsel - forkrøppet 180° Galvaniseret

Side door hinge, cranked  
Zinc-plated

### 50.013060S



#### Sidedørshængsel - Forkrøppet 180°. Rustfri

Side door hinge, cranked 180°, stainless

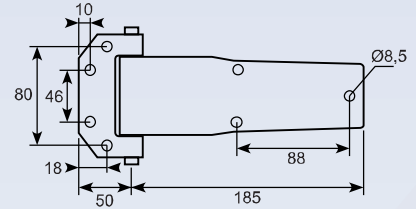

### 50.013070



#### Sidedørshængsel - lige 180° Galvaniseret

Side door hinge, straight 180°  
Zinc-plated

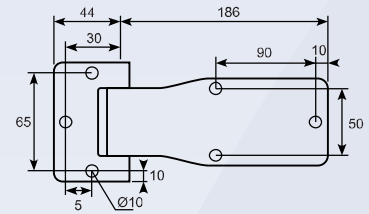

### 50.DL1100



#### Rustfri bladhængsel

Stainless hinge

### 50.DL1110



#### Rustfri bladhængsel, speciel flad model

Stainless hinge - flat model

A: 60 mm  
B: 20 mm  
C: 34 mm  
D: 60 mm  
E: 44 mm  
F: 10 mm  
G: 6 mm  
H: 4 mm  
I: Ø6,5 mm

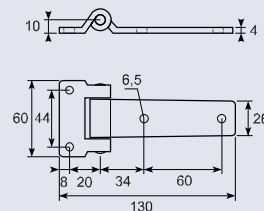

### 20.206

#### Bladhængsel med smørenippel Poleret rustfrit stål

Hinge with grease nipple  
Polished stainless steel

A: 70 mm  
B: 116 mm  
C: 65 mm

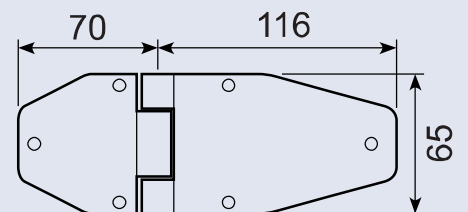

### 20.207

#### Bladhængsel med smørenippel Poleret rustfrit stål.

Hinge with grease nipple  
Polished stainless steel

A: 30 mm  
B: 116 mm  
C: 65 mm

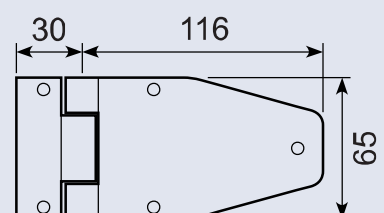

Godt køb / best buy

## 20.208R



### Bladhængsel Poleret rustfrit stål

Hinge  
Polished stainless steel

I: 9820/1151 = Ø8,2 mm  
J: 9820/1153 = 6,5 mm sqr.

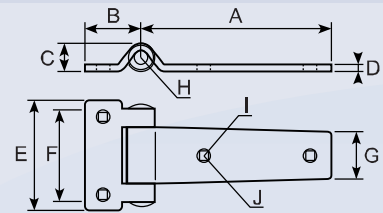

## 20.210



### Bladhængsel Poleret rustfrit stål

Hinge  
Polished stainless steel

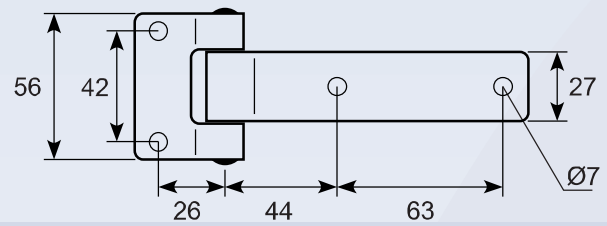
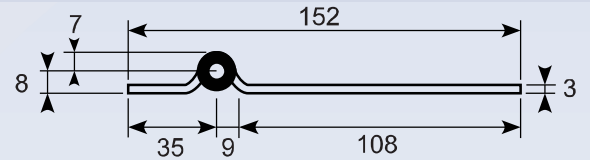

## 20.210J

### Bladhængsel Poleret rustfrit stål

Hinge  
Polished stainless steel

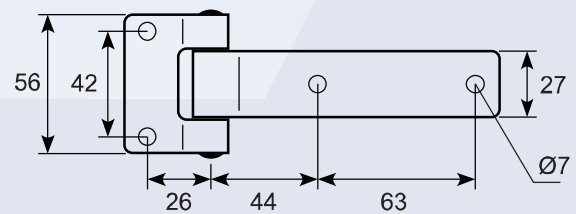
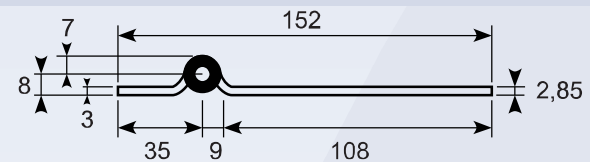

## 20.1370

### Bladhængsel med smørenippel Forkromet alloy.

Diecast profile hinge with grease nipple  
Zinc diecast alloy, chromium-plated



A: 82 mm  
B: 64 mm  
C: 50 mm  
D: 25 mm  
E: 120 mm  
F: 20 mm  
G: 32 mm  
H: 4 mm

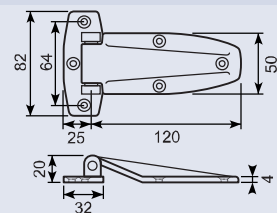

## 54.230840

### Sidedørshængsel, forkrøppet Rustfri

Stainless side door hinge, cranked

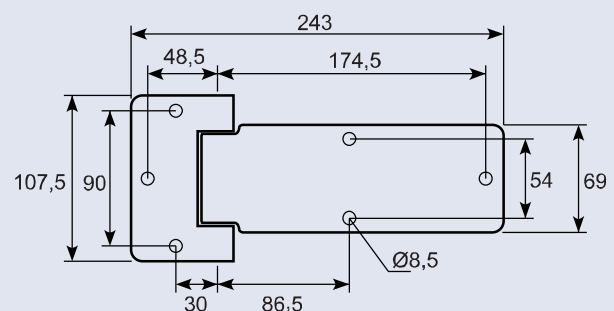

● Godt køb / best buy

54.230850

Sidedørshængsel, forkrøppet  
Rustfri

Stainless side door hinge, cranked



54.232200

Rustfri hængsel

Stainless rear door hinge

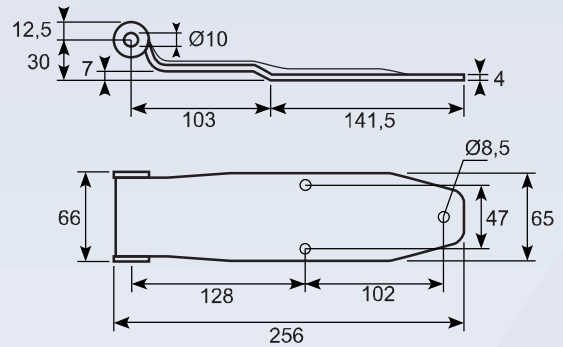

54.232210

Hængselbeslag til 54.232200. Rustfri.

Flat bracket with pin and nut for 54.232200

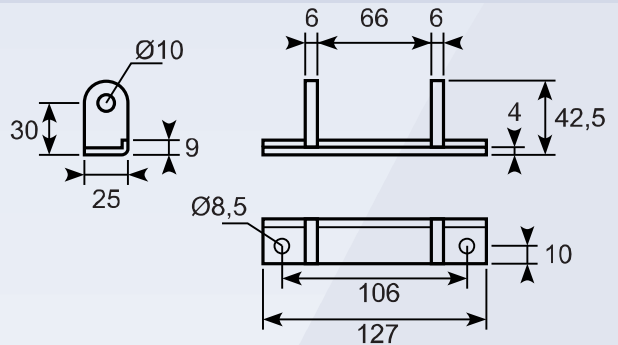

54.232215

Bolt M10, længde 90 mm

Pin M10, length 90 mm



50.011081

Hængselsblad, galvaniseret

Hinge bracket, zinc-plated  
Straight for welding

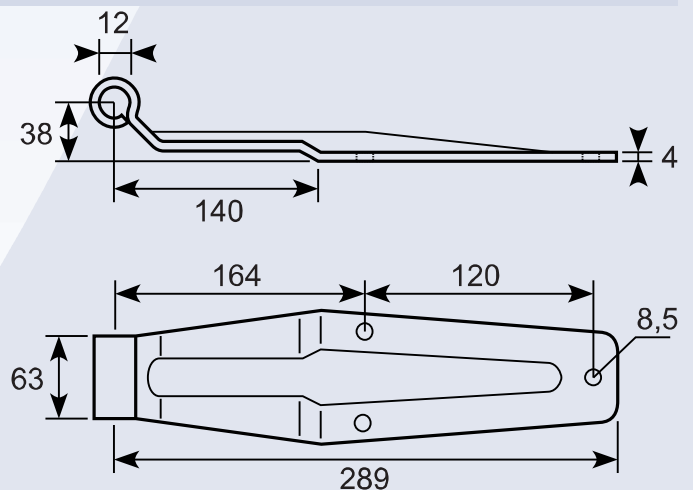

● Godt køb / best buy

### 50.011082-1



#### Hængselryg m. bolt og møtrik Galvaniseret

Hinge bracket with bolt and nut  
Zinc-plated, straight for welding

A: 63 mm  
B: 6 mm  
C: 38 mm  
D: Ø12 mm

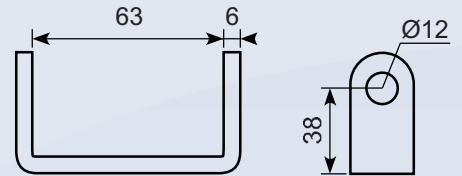

### 50.536



#### Galvaniseret hængsel Komplet m. bolt og møtrik

Zinc-plated hinge  
Complete with bolt and nut

B: 75 mm  
L: 293/280 mm  
H: 38 mm

### 50.DL1070



#### Rustfri bladhængsel

Flap hinge, stainless steel

### 50.DL1090



#### Rustfri forkrøppet bagdørshængsel

Stainless backdoor hinge

### 50.013070S



#### Sidedørshængsel - lige 180° Rustfri

Side door hinge, straight 180°  
Stainless steel

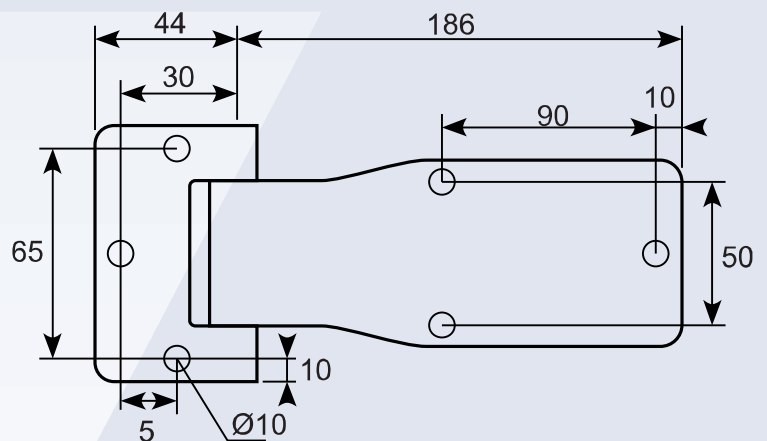

### 20.218R

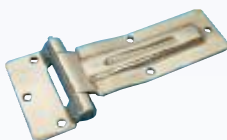

#### Bladhængsel Poleret rustfrit stål

Door hinge  
Polished stainless steel

Dim : 150 x 68/34  
mm

● Godt køb / best buy



## 20.221R

### Bladhængsel Galvaniseret jern

Rear van-door hinge  
Stainless steel

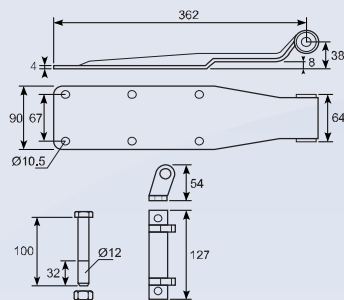

## 20.230



### Hængsel til værktøjskasse med smørenippel, rustfri.

Hinge for tool box.  
With grease nipple, item no. 2053

Bredde: 80 + 195  
mm  
Højde: 85 + 70 mm



## 50.DL1010



### Rustfri bladhængsel

Flap hinge, stainless steel

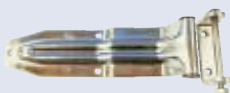

## 50.DL1020



### Rustfri bladhængsel

Flap hinge, stainless steel



## 50.DL1030



### Rustfri bladhængsel

Flap hinge, stainless steel



## 50.DL1040



### Rustfri bladhængsel

Flap hinge, stainless steel



## 50.DL1050



### Rustfri bladhængsel

Flap hinge, stainless steel



● Godt køb / best buy

## 50.DL1060



### Rustfri bladhængsel

Flap hinge, stainless steel



## 50.980H



### Hjertehængsel, galvaniseret, højre

5 x 230 x 135 mm

Zinc-plated hinge, RH

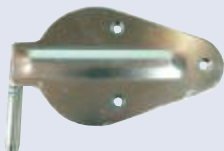

## 50.980V



### Hjertehængsel, galvaniseret, venstre

5 x 230 x 135 mm

Zinc-plated hinge, LH

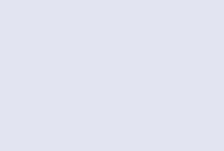

## 50.980HV



### Hjertehængsel, varmtgalvaniseret, højre

5 x 230 x 135 mm

Hot dip hinge, RH



## 50.980VV



### Hjertehængsel, varmtgalvaniseret, venstre

5 x 230 x 135 mm

Hot dip hinge, LH



## 50.981H



### Hjertehængsel, galvaniseret, højre

3 x 236 x 135 mm

Zinc-plated hinge, RH



## 50.981V



### Hjertehængsel, galvaniseret, venstre

3 x 236 x 135 mm

Zinc-plated hinge, LH



 Godt køb / best buy

### 50.014310-1



**Hængseløje, hun-del**  
**Ubehandlet stål**

Hinge eye, female part

120 x 40 mm  
H: 18 mm  
D: 70 mm

### 50.014310-1X



**Hængseløje, hun-del**  
**Ubehandlet, til svejsning**

Hinge eye, female part  
Raw, for welding

90 x 26 mm  
H: 17 mm  
D: 50 mm

### 50.014310-2



**Hængseløje, han-del**  
**Ubehandlet stål**

Hinge pin, male part

120 x 24 mm  
H: 42 mm  
D: 95 mm

### 50.014310-3



**Støtteplade i ubehandlet stål.**

Supporting plate

18 x 120 x 6 mm  
D: 95 mm

### 50.014320-1

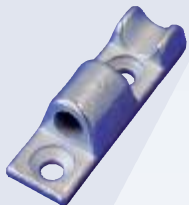

**Hængseløje, hun-del**  
**Ubehandlet stål**

Hinge eye, female part

90 x 26 mm  
H: 17 mm  
D: 50 mm

### 50.014320-2



**Hængseløje, han-del**  
**Ubehandlet stål**

Hinge pin, male part

90 x 22 mm  
H: 36 mm  
D: 70 mm

### 50.014320-3



**Støtteplade i ubehandlet stål.**

Supporting plate

18 x 90 x 6 mm

 Godt køb / best buy

18.2094/000



**Container lukkebeslag**  
**Komplet spindelbeslag - ubehandlet**  
**støbejern.**  
 Ramp fastener  
 Complete spindle fastener - cast iron

A: 170 mm  
 B: 165 mm  
 C: Ø20 mm  
 D: M16  
 E: 38 mm  
 F: 145 mm  
 G: 10 mm  
 H: 10 mm  
 I: 52 mm  
 J: 38 mm

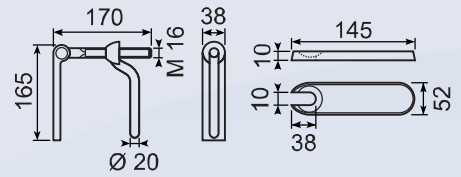

50.9576-1



**Varmtgalvaniseret holder**  
 Hot dip holder

50.9576-5



**Varmtgalvaniseret bagplade** 130 x 80 mm  
 Hot dip rear plate

50.9576-6



**Rustfri plade med buk, 5 huller, AISI 304**  
 Stainless plate with cover paper with bend + 5 holes AISI 304, no sharp edges.

A: 130 mm  
 B: 125 mm  
 C: 1,9 mm

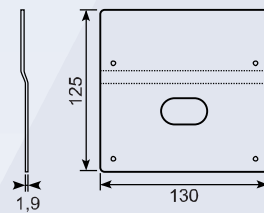

50.9576-7



**Rustfri plade, 6 huller, AISI 304**  
 Stainless plate with cover paper, with bend, 8 holes AISI 304, right model, no sharp edges.

A: 207 mm  
 B: 125 mm  
 C: 1,9 mm

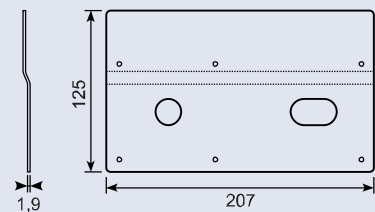

50.9576-8



**Rustfri plade med buk, 8 huller, AISI 304**  
**Venstre model**  
 Stainless plate with cover paper, with bend, 8 holes AISI 304, left model, no sharp edges.

A: 207 mm  
 B: 125 mm  
 C: 1,9 mm

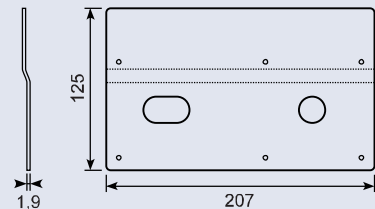

50.9576-9

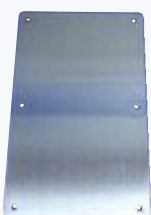

**Rustfri plade med buk , 6 huller, AISI 304**  
 Stainless plate with cover paper, with bend, with 6 holes AISI 304, no sharp edges.

A: 207 mm  
 B: 125 mm  
 C: 1,9 mm

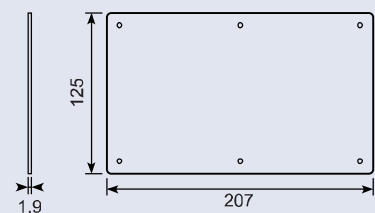

● Godt køb / best buy

52.V5030



**Værktøjskasse, kunststof, med T-håndtag og 1 Europlex lås**

Plastic toolbox with T-handle and 1 Europlex lock

A: 500 mm  
B: 350 mm  
C: 400 mm

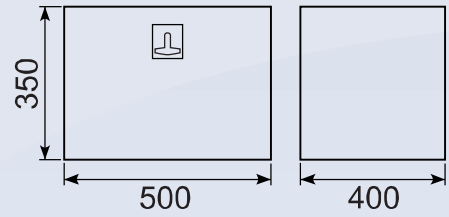

52.V5031



**Værktøjskasse, kunststof, med gasfjedre og 1 Europlex lås**

Plastic toolbox with T-handle, incl. gas spring and 1 Europlex lock

A: 500 mm  
B: 350 mm  
C: 400 mm

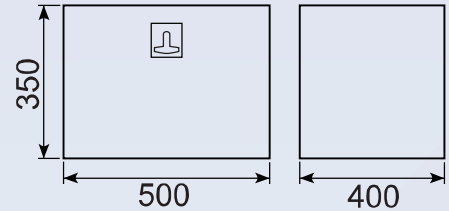

52.V5040



**Værktøjskasse, kunststof, med T-håndtag og 2 Europlex låse**

Plastic toolbox with T-handle and 2 Europlex locks

A: 600 mm  
B: 400 mm  
C: 500 mm

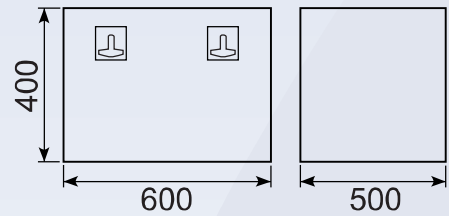

52.V5041



**Værktøjskasse, kunststof, med gasfjedre og 2 Europlex låse**

Plastic toolbox with T-handle, incl. gas spring and 2 Europlex locks

A: 600 mm  
B: 400 mm  
C: 500 mm

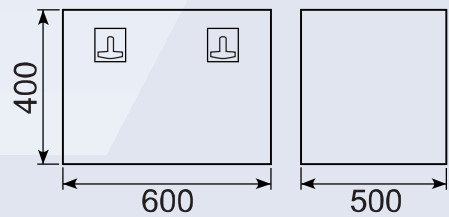

52.V5050



**Værktøjskasse, kunststof, med T-håndtag og 2 Europlex låse**

Plastic toolbox with T-handle and 2 Europlex locks

A: 800 mm  
B: 500 mm  
C: 500 mm

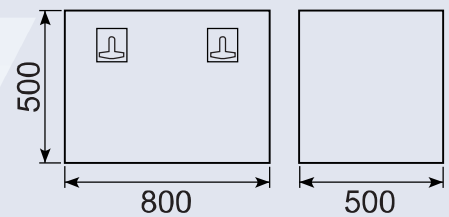

52.V5051



**Værktøjskasse, kunststof, med gasfjedre og 2 Europlex låse**

Plastic toolbox with T-handle, incl. gas spring and 2 Europlex locks

A: 800 mm  
B: 500 mm  
C: 500 mm

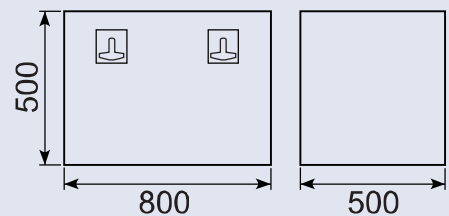

**52.V5060**
**Værktøjskasse, kunststof, med T-håndtag  
og 3 Europlex låse**

 Plastic toolbox with T-handle and with  
3 Europlex locks

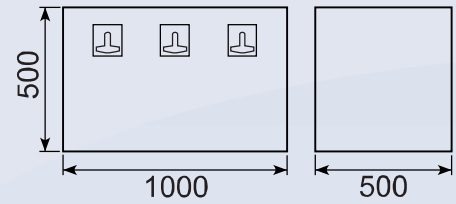
 A: 600 mm  
B: 400 mm  
C: 500 mm
**52.V5061**
**Værktøjskasser, kunststof, med gasfjedre  
og 3 Europlex låse**

 Plastic toolbox with T-handle, incl. gas spring  
and 3 Europlex locks

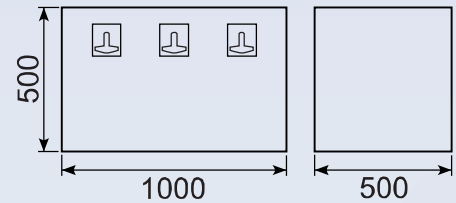
 A: 1000 mm  
B: 500 mm  
C: 500 mm
**52.V3515**
**Værktøjskasse, rustfri  
Materiale 1.5 mm med 1 Euroinox lås**

 Toolbox, stainless steel  
Material 1.5 mm with 1 Euroinox lock

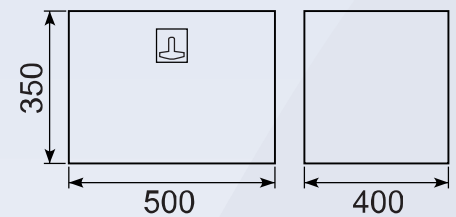
 A: 500 mm  
B: 350 mm  
C: 400 mm
**52.V3520**
**Værktøjskasse, rustfri  
Materiale 1.5 mm med 1 Euroinox lås**

 Toolbox, stainless steel  
Material 1.5 mm with 1 Euroinox lock

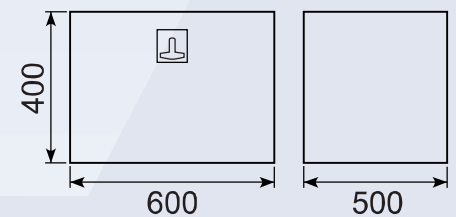
 A: 600 mm  
B: 400 mm  
C: 500 mm
**52.V3525**
**Værktøjskasse, rustfri  
Materiale 1.5 mm med 1 Euroinox lås**

 Toolbox, stainless steel  
Material 1.5 mm 1 Euroinox lock

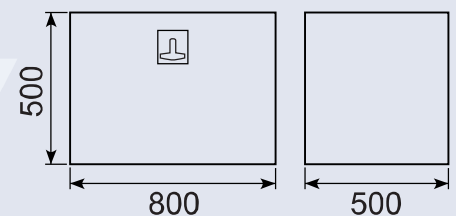
 A: 800 mm  
B: 500 mm  
C: 500 mm
**52.V3530**
**Værktøjskasse, rustfri  
Materiale 1.5 mm med 1 Euroinox lås**

 Toolbox, stainless steel  
Material 1.5 mm with 1 Euroinox lock

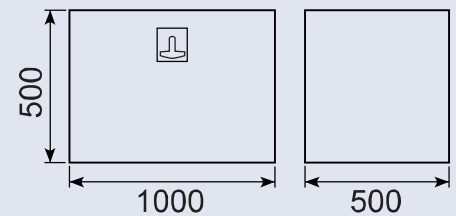
 A: 1000 mm  
B: 500 mm  
C: 500 mm
**52.V3535**
**Værktøjskasse, rustfri  
Materiale 1.5 mm med 2 Euroinox låse**

 Toolbox, stainless steel  
Material 1.5 mm with 2 Euroinox locks

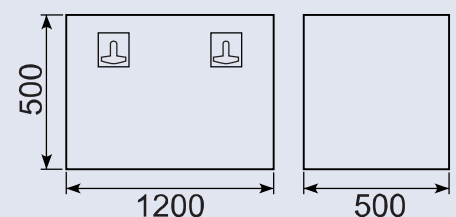
 A: 1200 mm  
B: 500 mm  
C: 500 mm

## 52.V3540



**Værktøjskasse, rustfri**  
**Materiale 1.5 mm med 2 Euroinox låse**

Toolbox, stainless steel  
Material 1.5 mm with 2 Euroinox locks

A: 1450 mm  
B: 500 mm  
C: 500 mm

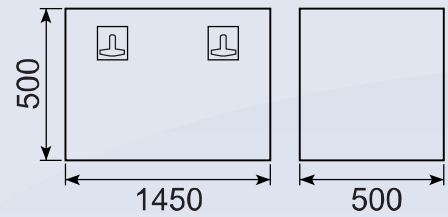

## 52.V2530X

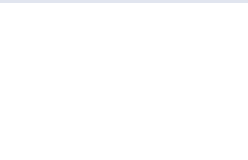

A: 1000 mm  
B: 500 mm  
C: 500 mm

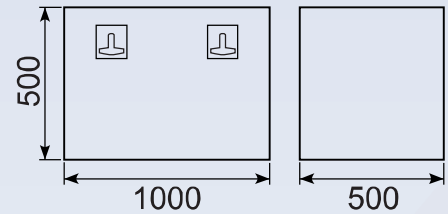

## 52.DK8925

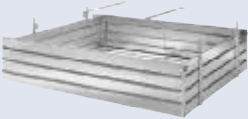

**Galvaniseret pallebox til 36 paller, zinkbelagt.**

Pallets carrier for 36 pallets, zinc-plated

A: 2750 mm  
B: 2450 mm  
C: 635 mm

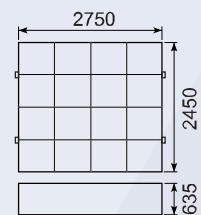

## 52.DK8935

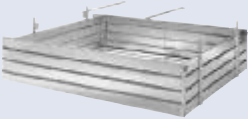

**Cirkelpoleret rustfri pallebox til 36 paller**

Pallets carrier for 36 pallets, flowered stainless

A: 2750 mm  
B: 2450 mm  
C: 635 mm

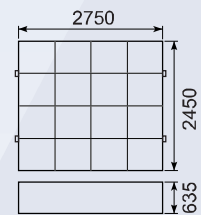

## 52.V5091

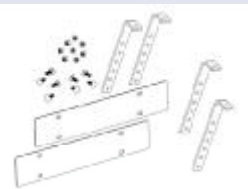

**Monteringsbeslag, vertikal**  
**Passer til V5030 - V5031**

Brackets for plastic toolbox V5030 - V5031,  
vertical fixing

## 52.V5092

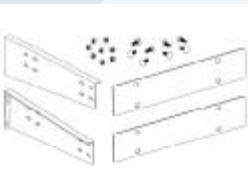

**Monteringsbeslag, horisontal**  
**Passer til V5030 - V5031**

Brackets for plastic toolbox V5030 - V5031,  
horizontal fixing

## 52.V5094



**Monteringsbeslag, vertikal**  
**Passer til V5040 - V5041 - V5050**  
**V5051 - V5060 - V5061**

Brackets for plastic toolbox V5040 - V5041  
- V5050 - V5051 - V5060 - V5061, vertical  
fixing

## 52.V5095

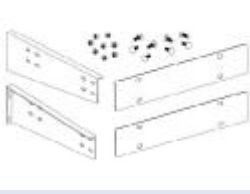

**Monteringsbeslag, horisontal**  
**Passer til V5040 - V5041 - V5050**  
**V5051 - V5060 - V5061**

Brackets for plastic toolbox V5040 - V5041 - V5050 - V5051 - V5060 - V5061, horizontal fixing

## 52.V9515



**Monteringsbeslag, galvaniseret, passer til serie V25, sortlakeret gods**

Brackets couple, zinc-plated for toolboxes series V25, black wall

## 52.V9520



**Monteringsbeslag, galvaniseret, passer til serie V25, sortlakeret gods**

Brackets couple, zinc-plated for toolboxes series V25, black wall

## 52.V9525



**Monteringsbeslag, rustfri**  
**Passer til serie: V25, V35, V36, V37, V40, V45**

Brackets couple, stainless steel  
For toolboxes series V25, V35, V36, V37, V40, V45

## 52.V9530



**Monteringsbeslag, rustfri**  
**Passer til serie V25, V35, V36, V37, V40, V45**

Brackets couple, stainless steel  
For toolboxes series V25, V35, V36, V37, V40, V45

## 52.TK2005

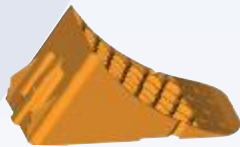

**Stopklods - gul kunststof**

Chock - yellow plastic

## 52.TK2050

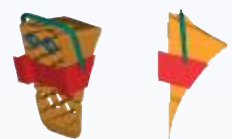

**Holder for stopklods**  
**Kunststof**

Chock holder  
Plastic



## 52.TK2055

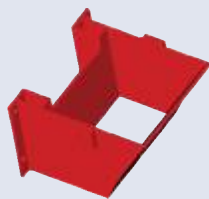

### Holder for stopklods Varmgalvaniseret

Chock holder  
Zinc-plated

## 52.V6510



### Ildslukkerkasse. Sort plastik. 6 kg. Fire extinguisher box, black plastic, 6 kg

L: 310 mm  
H: 675 mm  
B: 250 mm

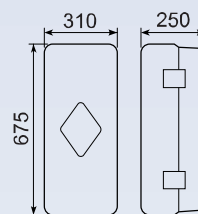

## 52.V6520



### Ildslukkerkasse. Sort og rød plastik. 6 kg. Fire extinguisher box, black and red plastic, 6 kg

L: 310 mm  
H: 675 mm  
B: 250 mm

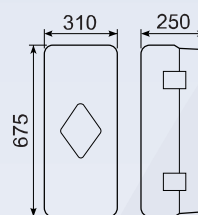

Halvskærm

Vare nr.	A	Sv
	mm	mm
52.DK1110	430	700
52.DK1115	500	700
52.DK1120	550	700
52.DK1125	600	700
52.DK1130	670	700
52.DK1135	430	800
52.DK1140	500	800
52.DK1145	550	800
52.DK1150	600	800
52.DK1155	670	800
52.DK1160	430	1000
52.DK1165	670	1000

Plastik halvskærm med hvid kant

Plastic half wing with white edge



Halvskærm med holder

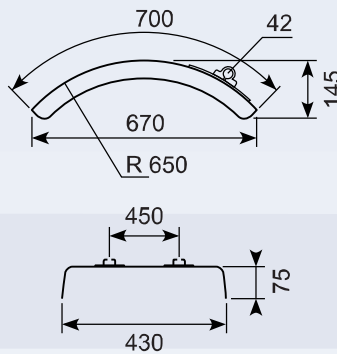

Plastik halvskærm m. integreret skærmholder

Plastic half wing with adjustable supports

Vare nr.	B	L	R	S	H	V	C	Ø
	mm	mm	mm	mm	mm	mm	mm	mm
52.DK2010	430	700	650	670	145	75	450	42
52.DK2015	500	700	550	650	160	75	450	42
52.DK2030	670	700	670	670	140	75	450	42
52.DK2035	430	800	650	755	165	75	210	42
52.DK2040	500	800	550	730	185	75	450	42
52.DK2055	670	800	670	755	160	75	450	42
52.DK2060	430	1000	650	910	225	75	210	42
52.DK2065	670	1000	670	910	225	75	450	42
52.DK2110	430	700	650	670	145	75	210	42
52.DK2115	500	700	550	650	160	75	450	42
52.DK2130	670	700	670	670	140	75	450	42
52.DK2135	430	800	650	755	165	75	210	42
52.DK2140	500	800	550	730	185	75	450	42
52.DK2155	670	800	670	755	160	75	450	42
52.DK2160	430	1000	650	910	225	75	210	42
52.DK2165	670	1000	670	910	225	75	450	42

## 52.800



**Sort single trailerskærm PE. Ca. 0.85kg**

Single mudguard PE, black

## 52.801



**Sort bogjie trailerskærm PE. Ca. 1.90kg**

Bogje mudguard PE, black

## Helskærme

Vare nr.	B	L	S
	mm	mm	mm
52.DK1615	410	1350	860
52.DK1620	450	1350	860
52.DK1635	500	1700	1100
52.DK1640	550	1700	1100
52.DK1650	550	1900	1280
52.DK1655	600	1700	1100
52.DK1665	600	1900	1280
52.DK1670	650	1900	1280
52.DK1675	430	1900	1300
52.DK1680	430	2125	1300
52.DK1685	670	2125	1340



**Plastik helskærm m. hvid kant**

Plastic mudguard with white border

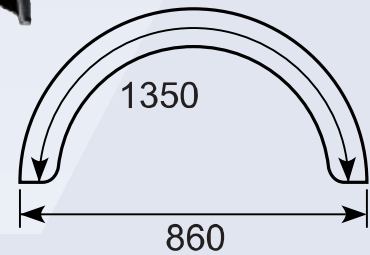

## 52.DK3110



**Plastikskærm, flad top med hvid kant**

Plastic, flat-topped mudguard with white border

B: 260 mm  
L: 1450 mm  
R: 380 mm  
S: 880 mm  
H: 450 mm  
F: 400 mm

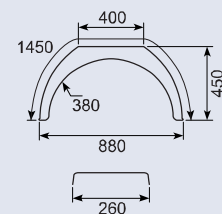

## 52.DK3115



**Plastikskærm, flad top med hvid kant**

Plastic, flat-topped mudguard with white border

B: 450 mm  
L: 1480 mm  
R: 400 mm  
S: 920 mm  
H: 460 mm  
F: 400 mm

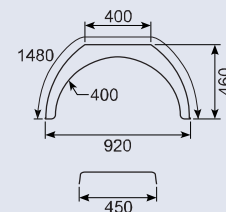

## 52.DK3120



**Plastikskærm, flad top med hvid kant.**

Plastic, flat-topped mudguard with white border

B: 510 mm  
L: 1770 mm  
R: 430 mm  
S: 1000 mm  
H: 550 mm  
F: 510 mm

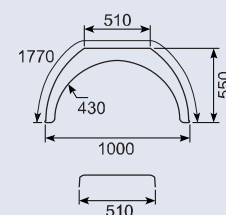

Godt køb / best buy

## 52.DK1510



### Plastik helskærm

Plastic mudguard

B: 270 mm  
S: 840 mm  
L: 1300 mm

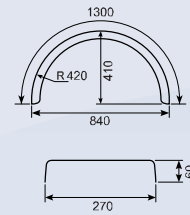

## 52.DK4670

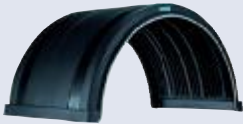

### Plastik helskærm med hvid kant og anti splash

Plastic mudguard with white border and anti splash.

b: 1250 mm  
a: 670 mm  
Sv: 1950 mm

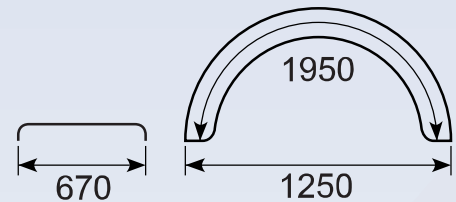

## Zink halvskærm

Vare nr.	B	L
	mm	mm
52.T5010	500	700
52.T5015	600	700
52.T5020	650	700
52.T5025	500	800
52.T5030	600	800
52.T5035	650	800
52.T5040	500	1000
52.T5045	650	1000



### Half wing, zinc-plated with rubber edge

Zink halvskærm  
Kan også leveres som helskærm

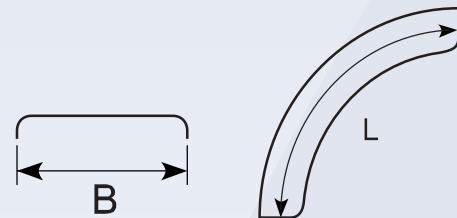

## Zink helskærm

Vare nr.	B	L	S
	mm	mm	mm
52.T5110	240	1250	820
52.T5115	400	1250	880
52.T5120	400	1350	880
52.T5125	450	1350	880
52.T5130	420	1420	920
52.T5135	450	1500	1000
52.T5140	500	1500	1000
52.T5145	550	1700	1110
52.T5150	600	1800	1115
52.T5155	650	1800	1115
52.T5160	550	1900	1200
52.T5165	450	2000	1340
52.T5170	600	2000	1340
52.T5175	650	2000	1340

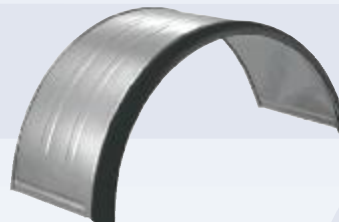

### Zink helskærm

Kan også leveres som hel stålskærm

Mudguard, zinc-plated with rubber edge

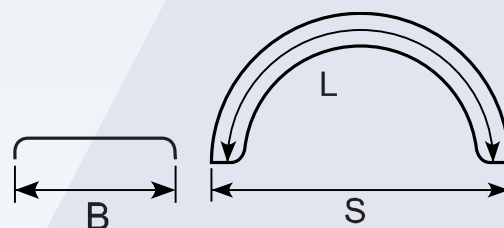

## Zink stor skærm

Vare nr.	B	L	S
	mm	mm	mm
52.T5210	600	3500	2740
52.T5215	650	3500	2740
52.T5220	500	4750	3950
52.T5225	650	4750	3950
52.T5230	650	8500	7500
52.T5235	650	8500	7500



### Stor zink helskærm

Kan også leveres som hel stålskærm

Mudguard, zinc-plated with rubber edge

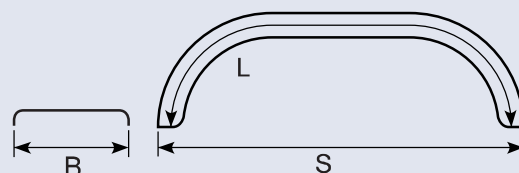

## 52.DK6810

### Buede stænkborster til skærme

Curved brush mudguards



## Anti spray

Vare nr.	A	B
	mm	mm
52.DK5010	420	600
52.DK5015	420	700
52.DK5020	420	800
52.DK5030	500	600
52.DK5035	500	700
52.DK5040	500	800
52.DK5050	600	600
52.DK5055	600	700
52.DK5060	600	800
52.DK5070	650	600
52.DK5075	650	700
52.DK5080	650	800

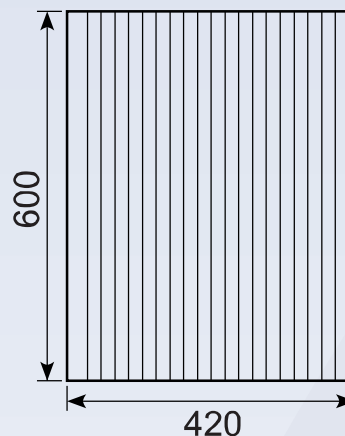

## Skærmholdere C-profil

Vare nr.	A	B	C	D	L	Kvalitet
	mm	mm	mm	mm	mm	
51.2966	58	50	40	48	600	Olieret
51.2966G	58	50	40	48	600	Galvaniseret
51.2968	58	50	40	48	700	Olieret
51.2968G	58	50	40	48	700	Galvaniseret

### Skærmholdere C-profil

Stay C-profile, untreated

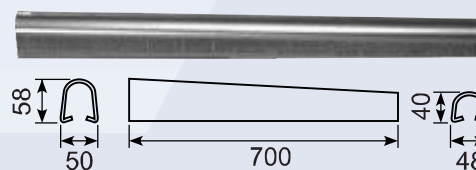

## 51.2971

### Boltsæt til C-profil

1 stk. skive 1 stk. profilskiye  
1 stk. bolt 1 stk. skærmskive

Set of bolts for C-profile consisting of:  
Washer, profile washer, bolt and cover



## 51.2980

Underlagsplade, Uni-Form  
1,5 mm galvaniseret stålplade

A: 300 mm  
B: 70 mm

Baseplate, Uni-Form, for plastic and rubber  
stays  
1.5 mm zinc-plated steel sheet

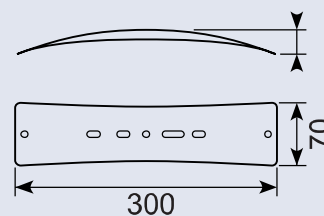

## 52.D8798

Skærmholdere, sort pulverlakeret  
Gods 2.5 mm

Stay, curved, black powder-coated  
Wall 2.5 mm

### 52.DK8010

Skærmholdere, sort pulverlakeret  
Gods 2.5 mm

A: 580 mm  
B: Ø42 mm



Stay, straight, black powder-coated  
Wall 2.5 mm

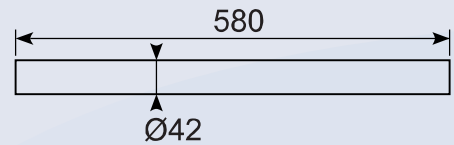

### 52.DK8012

Skærmholdere, sort pulverlakeret  
Gods 2.5 mm

A: 800 mm  
B: Ø42 mm



Stay, straight, black powder-coated  
Wall 2.5 mm

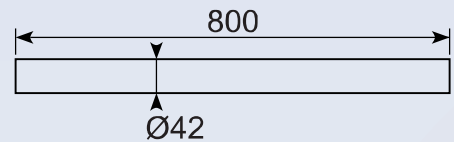

### 52.DK8014

Skærmholdere, kurvede, pulverlakeret  
sort  
Gods 2.5 mm

A: 580 mm  
B: 310 mm  
C: 100 mm  
D: 100 mm  
E: Ø42 mm



Stay, curved, black powder-coated  
Wall 2.5 mm

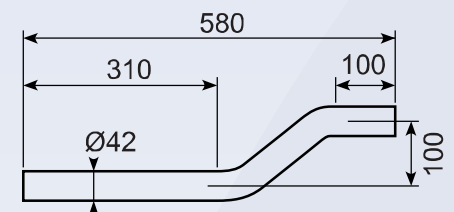

### 52.DK8016

Skærmholdere, kurvede, pulverlakeret  
sort  
Gods 2.5 mm

A: 800 mm  
B: 530 mm  
C: 100 mm  
D: 100 mm  
E: Ø42 mm



Stay, curved, black powder-coated  
Wall 2.5 mm

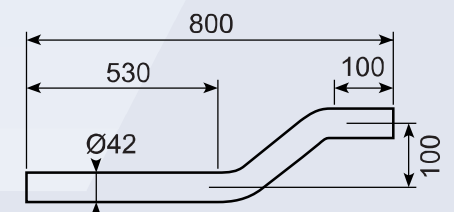

### 52.DK8020

Skærmholdere, montering direkte på  
chassis, pulverlakeret sort  
Gods 2.5 mm

A: 580 mm  
B: Ø42 mm  
C: Bolt M16



Stay, curved, attached to chassis, black  
powder-coated  
Wall 2.5 mm

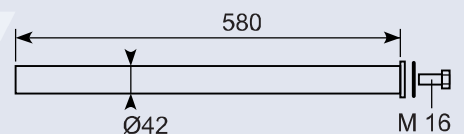

### 52.DK8022

Skærmholdere, montering direkte på  
chassis, pulverlakeret sort  
Gods 2.5 mm

A: 800 mm  
B: Ø42 mm  
C: Bolt M16



Stay, straight, attached to chassis,  
black powder-coated  
Wall 2.5 mm

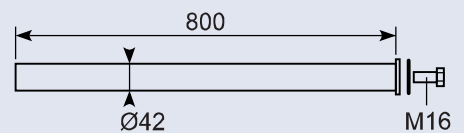

### 52.DK8024

Skærmholdere, kurvede, montering  
direkte på chassis, pulverlakeret sort  
Gods 2.5 mm

A: 580 mm  
B: 310 mm  
C: 100 mm  
D: 100 mm  
E: Ø42 mm  
F: Bolt M16



Stay, curved, attached to chassis,  
black powder-coated  
Wall 2.5 mm

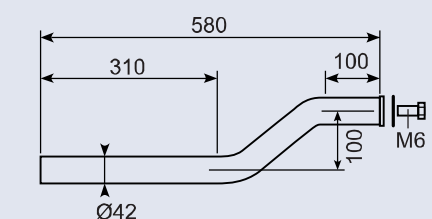

**52.DK8026**

**Skærmholdere, kurvede, montering direkte på chassis, pulververlakeret sort Gods 2.5 mm**

Stay, curved, attached to chassis, black powder-coated  
Wall 2.5 mm

A: 800 mm  
B: 530 mm  
C: 100 mm  
D: 100 mm  
E: Ø42 mm  
F: Bolt M16

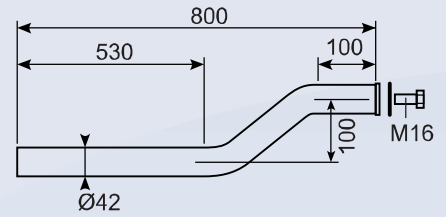
**52.DK8054**

**Skærmholdere, montering direkte på chassis, pulverlakeret sort Gods 2.5 mm**

Stay, curved, attached to chassis, black powder-coated  
Wall 2.5 mm

A: 560 mm  
B: 150 mm  
C: Ø42 mm

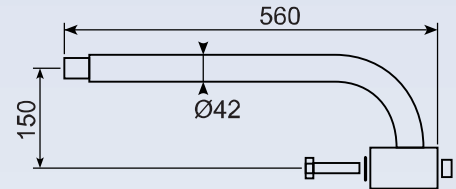
**52.DK8110**

**Fast befæstigelse til skærm**

Plastic fixed support for mudguard

A: 150 mm  
B: 42 mm  
C: Ø42 mm

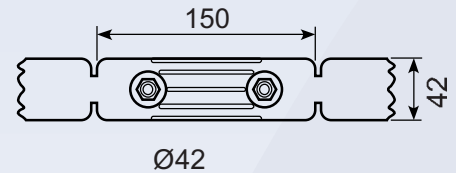
**52.DK8115**

**Justérbar befæstigelse for skærme, sort metal**

Adjustable support for mudguard, black metal

A: 338 mm  
B: 50 mm  
C: Ø42 mm

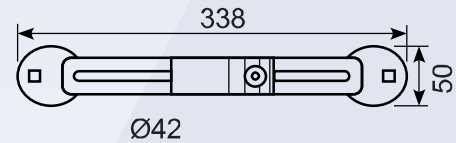
**52.DK8120**

**Justérbar befæstigelse for skærme, galvaniseret**

Adjustable support for mudguard, zinc-plated

A: 338 mm  
B: 50 mm  
C: Ø42 mm

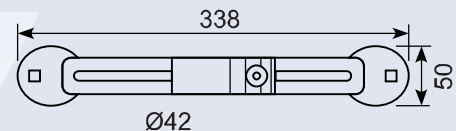
**52.DK8125**

**Justérbar befæstigelse for skærme, plast**

Adjustable support for mudguard, plastic

A: 360 mm  
B: 70 mm  
C: Ø42 mm

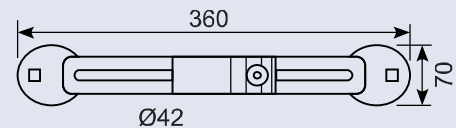
**52.DK8130**

**Justérbar befæstigelse for skærme, plast.**

Adjustable support for mudguard, plastic

A: 360 mm  
B: 70 mm  
C: Ø54 mm

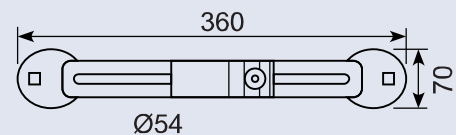

**52.DK8210****Plastikholder for skærmstivere**

Support for stay, plastic

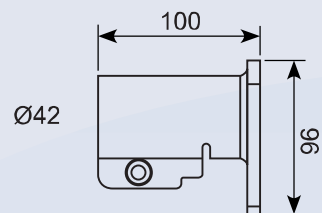
A: 100 mm  
B: 96 mm  
Ø42 mm**52.DK8215****Galvaniseret holder for skærmstivere**

Support for stay, zinc-plated

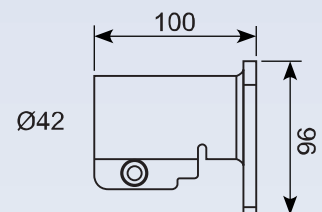
A: 100 mm  
B: 96 mm  
Ø42 mm**52.DK8220****Galvaniseret holder for skærmstivere**

Support for stay, zinc-plated

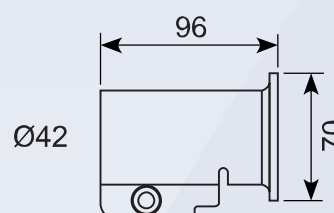
A: 96 mm  
B: 70 mm  
Ø42 mm**52.DK8225****Stålmanchet for skærmstivere.  
Galvaniseret.**

Coupling for stay, steel

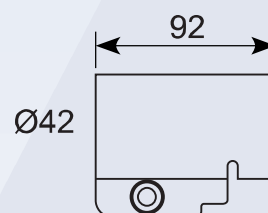
A: 92 mm  
Ø42 mm



52.659A

Neutral stænklap med vulst  
Andre størrelser kan også leveres

60 x 40 mm

Neutral mudflap with fixing track  
Other sizes are available

Monteringsskinner

Vare nr.	mm
52.501P	400
52.502P	450
52.503P	500
52.504P	550
52.505P	600
52.506P	650
52.507P	700



Monteringsskinne i PVC til stænklapper med vulst

PVC fixing bar for mudflaps with fixing track

Stænklapper



Vi kan levere stænklapper i mange udførelser og med jeres logo i flere farver.  
Kontakt os for mere information.

## Stiger, konsoller og lygtebomme / Ladders, Brackets and Bumpers

### Udtræksstiger

Vare nr.	Trin	Længde mm
52.DK8610	1	400
52.DK8615	2	570
52.DK8620	2	660
52.DK8625	3	750



#### Udtræksstiger El-galvaniseret

Pull-out ladder  
Cold zinc-plated

### Udtræksstiger

Vare nr.	Trin	Længde mm
52.DK8630	1	400
52.DK8635	2	570
52.DK8640	2	660
52.DK8645	3	750



#### Udtræksstige. Rustfri.

Pull-out ladder  
Stainless steel

### Udtræksstiger

Vare nr.	Trin	Længde mm
52.DK8650	1	400
52.DK8655	2	570
52.DK8660	2	660
52.DK8665	3	750



#### Udtræksstige. Galvaniseret.

Pull-out ladder  
Zink-plated

### 50.DL7302SS-572



#### Rustfri cykelistværn, stolpe

Stainless safeguard

50 x 50 x 572 mm  
Indbygningslængde/  
Dimensions: 612  
mm



### 50.DL7302SS-735



#### Rustfri cykelistværn, stolpe

Stainless safeguard

50 x 50 x 735 mm  
Indbygningslængde/  
Dimensions: 775  
mm



### 50.DL7302ZP-572



#### Galvaniseret cykelistværn, stolpe

Zinc-plated safeguard

A: 612 mm  
B: 50 mm  
C: 150 mm  
Stolpelængde/Post  
length:  
572 mm

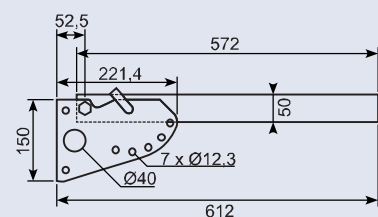

● Godt køb / best buy

## 50.DL7302ZP-735



### Galvaniseret cykelistværn, stolpe

Zinc-plated safeguard



A: 775 mm  
B: 50 mm  
C: 150 mm  
Stolpelængde/post  
length:  
735 mm

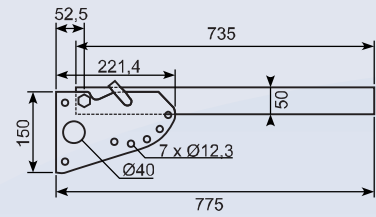

## 52.TK3015

### Galvaniseret konsol for sideværn

Zinc-plated bracket for side-protecting bars



A: 735 mm  
B: 59 mm  
C: 150 mm

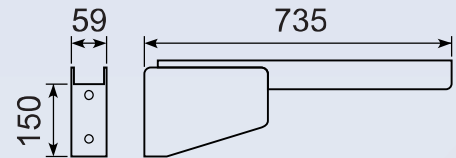

## Lygtebomme

Vare nr.	a	b	c
	mm	mm	mm
52.TK7510	1800	225	105
52.TK7515	1900	225	105
52.TK7520	2000	225	105
52.TK7525	2100	225	105
52.TK7530	2200	225	105
52.TK7535	2300	225	105
52.TK7540	2400	225	105

### Lygtebom - grålakeret med endestykker

Bumper - grey with heads

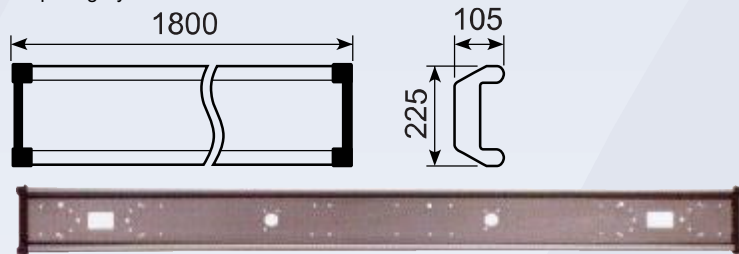

## Lygtebomme

Vare nr.	a	b	c
	mm	mm	mm
52.TK7615	1900	225	105
52.TK7625	2100	225	105
52.TK7635	2300	225	105

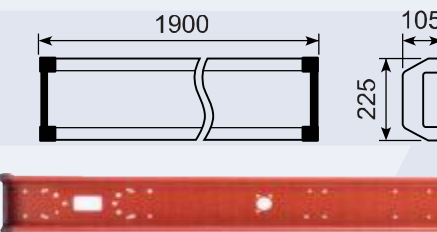

### Lygtebom - cirkelpoleret rustfri stål med endestykker

Bumper - flowered SS with heads

## Lygtebomme

Vare nr.	a	b	c
	mm	mm	mm
52.TK7735	2300	225	105
52.TK7740	2400	225	105

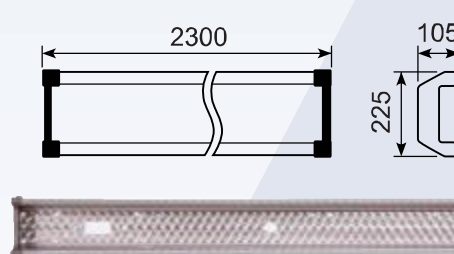

### Lygtebom - cirkelpoleret rustfri stål med endestykker

Bumper - flowered SS with heads

## 52.TK9445

### Plastikender til lygtebom

Heads for bumpers, plastic



● Godt køb / best buy

## Surrings Skinner og gjorde / Load bonding tracks and girths

### 52.TK4010

**Surringskinne  
Galvaniseret**

Load Bonding Track  
Zinc-plated



A: 2988 mm  
B: 65 mm  
C: 54 mm  
D: 25 mm  
E: 40 mm  
F: 12 mm  
G: Ø4 mm

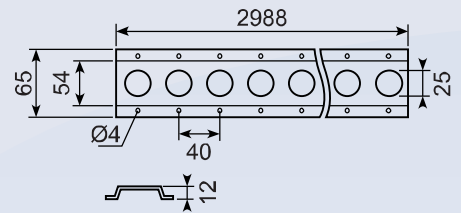

### 50.033020



**Surringskinne  
Galvaniseret**

Load bonding track, zinc-plated, keyhole type



A: 3000 mm  
B: 408 mm  
C: 82 mm  
D: 46 mm  
E: 18 mm  
F: 41 mm  
G: Ø25 mm

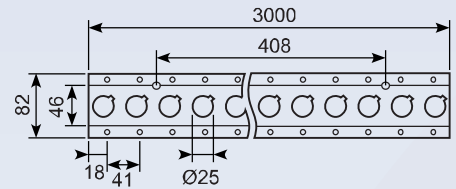

### 50.033010



**Surringskinne  
Galvaniseret**

Load bonding track, zinc-plated

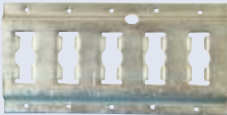

A: 3050 mm  
B: 410 mm  
C: 132 mm  
D: 114 mm  
E: 60 mm  
F: 14 mm  
G: Ø25 mm  
H: 51 mm  
I: Ø5 mm

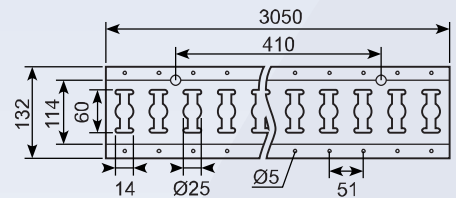

### 55.1818

**Teleskopstang**

2,40 - 2,50 m

Shoring pole



### 55.1818EL

**Teleskopstang**

2,50 - 2,60 m

Shoring pole



### 55.1866F

**Lastholder med fjeder, justerbar med én  
fod**

2,38 - 2,76 m

Cargo keeper with spring and plug



 Godt køb / best buy

### 55.1809X



**Anker ende. Passer til skinne 50.033020.**

Anchor part. Fits 50.033020

### 55.1809Y



**Anker ende med snapbeslag. Passer til skinne 50.033010.**

Anchor ends web, fitting 50.033010.

### 55.1812



**Spændegjord med skralde 3,6m  
911/1504/1005-3.5m/.5m**

Straps buckle 911 webbing 1504, hooks  
1005, length 3,5 m

### 55.1821



**Bånd, 9 meter. Med dobbeltkrog**

Rewinder without girth. 9 meter.

### 55.2730



**Bånd og båndstrammer med  
kantbeskytter og dobbeltkrog.  
Op til 2 tons belastning 8 meter.**

Girth 1.25 m with fitting No. 1065

### 55.2810



**Bånd og båndstrammer 9 m og  
belastning op til 5 tons.**

Lashing straps 9 metres

### 55.2811



**Bånd og båndstrammer 3,5 meter**

Unit hook with buckle, 3.5 m long

55.2815

**Strophenhed med flade kroge 2.0m**

Strap unit with flat hooks, 2.0 m



55.2816

**Bånd og båndstrammer 2,3 meter. Med carabinhage.**

Strap unit with safety hook and buckle, 2.30 m



55.2817

**Strophenhed 2.30m med carabinhage og klemme befæstigelse LG.2.30**

Strap unit with safety hook, 2.30 m



55.2835

**Strophenhed 5m længde u/krog (450kg)**

Strap unit no hook, 5 m length



55.2836

**Strophenhed 5m for rudemontering med 2 kroge. (450kg)**

Strap unit with 2 hooks, 5 m



55.2906

**Bånd med krog 10 m**

Strap with hook, 10 m

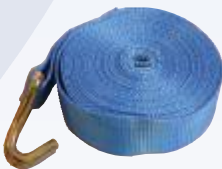

55.4429-250

**Suringsbånd 5m (1.000kg)**

Lashing strap , 5 m (1000 kg)



55.4429-500



**Bånd og båndstrammer, 5 meter  
belastning op til 1000 kg. Passer til  
skinne 50.033010**

Lashing strap, 5 m (1000 kg). Fits 50.033010

50.DL7120



**Rustfri båndstrammer**

Stainless strapping tool



 Godt køb / best buy

## 50.3009ALU

Alu combiskinne 3m lang og rund.Alu  
combi-track 3 m

3050 x 133 x 3 mm  
Ø25 hul

## 20.2828



Surringsøje - galvaniseret

Ø: 23 mm

Galvanised ring

## 50.295J



Bindering i sort PVC skål

Ø100 mm

Tie-down ring in plastic housing 97mm

T: 12 mm

## 50.70672



Rustfri surringsskål  
4 stk. Ø 5 mm huller  
Tværpind: Ø 6 mm

Ø: 120 mm  
T: 23 mm

Load ring, stainless steel, with 4 Ø5 mm  
holes.

## 50.039530V



Surringsøje, varmt galvaniseret med  
fjeder.

95 x 102 mm  
belastning: 1960 kg

Lashing ring, hot zinc coated with spring

## 50.039530



Galvaniseret bindering i skål

B: 95 mm

Lashing ring, zinc-plated with spring

H: 102 mm

T: 25 mm



### 50.039530-1

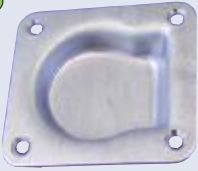

#### Løs skål til surringsøje u. hul i siden

Loose bowl for lashing ring without hole in side, zinc-plated

### 50.039530S



#### Rustfri binding i skål

Lashing ring, stainless with spring

B: 95 mm  
H: 102 mm  
T: 25 mm

### 50.9644



#### Binding i galvaniseret skål Med bagplade

Load ring in galvanized bowl with back plate

150 x 114 mm  
Belastning: 2000 kg

### 50.039070



#### Surringsøje - Sort lakeret

Lashing eye, black enameled

105 x 66 x 32 mm

### 50.039060

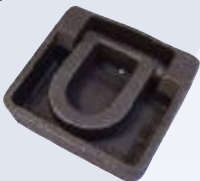

#### Surringsøje, ubehandlet

Lashing eye, raw

97 x 90 x 30 mm

23.P318

Mørkegrå busstrop med plastklemme

Bus strap with plastic clip, dark-grey



50.241EPDM

T-strop - EPDM kvalitet

L: 150 mm

T-strap, EPDM



50.241NR

T-strop - NR kvalitet

L: 150 mm

T-strap, NR



50.242EPDM

T-stige - EPDM kvalitet

L: 250 mm

T-strap, EPDM



50.242NR

T-stige - Kvalitet :NR

L: 250 mm

T-strap, NR



50.243EPDM

Oval - Kvalitet: EPDM

L: 260 mm

Oval-shaped strap, EPDM



**50.243NR**

**Oval - NR kvalitet**  
Oval-shaped strap, NR

L: 260 mm

**50.244EPDM**

**4-stige - EPDM kvalitet**  
Strap, 4-holes, EPDM

L: 260 mm

**50.244NR**

**4-stige - Kvalitet: NR**  
Strap, 4-holes, NR

L: 260 mm

**50.245EPDM**

**T-stige - EPDM kvalitet**  
Strap, 2 holes, EPDM

L: 160 mm

**50.245NR**

**T-stige - Kvalitet: NR**  
Strap, 2 holes, NR

L: 160 mm

**50.246EPDM**

**T-stige - EPDM Kvalitet**  
Strap, 3 holes, EPDM

L: 260 mm

**50.246NR**

**T-stige - NR kvalitet**  
Strap, 3 holes, NR

L: 260 mm

#### 50.247EPDM

**Kombi - EPDM kvalitet**

L: 380 mm

Combi, EPDM



#### 50.247NR

**Kombi - NR kvalitet**

L: 380 mm

Combi, NR



#### 50.275EPDM

**Stige POP - Kvalitet: EPDM**

L: 200 mm

Strap POP, EPDM



#### 50.276

**Stige POP - Kvalitet: EPDM**

L: 275 mm

Strap POP, EPDM



#### 50.261

**Strop, kvalitet EPDM**

L: 200 mm

Strap, EPDM



#### 50.263K

**Strop, oval m. krog, kvalitet NR**

L: 200 mm

Strap, oval with hook, NR



#### 50.263NR

**Strop, oval, kvalitet NR**

L: 200 mm

Strap, oval, NR



### 50.264NR

**Strop, 4-stige m. hul, kvalitet NR**

L: 290 mm

Strap NR, 4 holes



### 50.265EPDM

**Kombi-strop, lille, kvalitet EPDM**

L: 280 mm

Strap EPDM short, Combi



### 50.267NR

**Strop, oval, kvalitet NR**

L: 400 mm

Strap oval, NR



### 50.269

**Ring, kvalitet EPDM**

Ø: 106/86 mm

Tarpaulin strap, round



### 50.270

**Fæsterem - Kvalitet: PVC**

L: 120 mm

H: 17 mm

Fixing strap with hook, PVC fabric



### 50.280

**Gummistrop til f.eks. transportbure**

L: total 610 mm

L: strop 480 mm

Rubber strap for e.g. transport boxes



### Bagageremme

Vare nr.	Mål
	mm
79.051	600
79.051A	700
79.052	900
79.053	1250
79.054	1750
79.055	3000

**Bagagerem med krog**

Luggage strap



50.250



**Stigestrop - SBR kvalitet**

L: rulle á 10 meter

Tarpaulin strap, quality SBR

50.252J



**PVC.knap, sort. Poser med 100 stk.**

Ø: 24 mm

Knob, black HDPE, 1 unit with 100 pcs.,  
HDPE 7200, high density polyethylene

50.252JX



**PVC.knap, sort. Hul Ø6 mm +-0,1 mm.  
Poser med 100 stk.**

Ø: 24 mm

Knob, black HDPE, 1 unit with 100 pcs.,  
HDPE 7200, high density polyethylene

50.253

**Skrue til PVC 50.252J**

Screw for knob, electro-galvanized,  
self-tapping, 25 mm cross recess, suits  
50.252/50.252JX

50.200

**Galvaniseret krog**

19 x 40 mm

Line hook, zinc-plated



50.232

**Galvaniseret øjekrog**

40 x 50 mm

Line hook, zinc-plated





50.251

**PVC-krog, grå**

40x45 mm

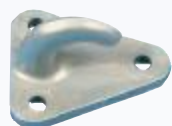
Triangular line hook, synthetic material, grey



 Godt køb / best buy

Anti chok buffer

Vare nr.	A	B	C
	mm	mm	mm
52.V7010	160	60	100
52.V7015*	160	60	100
52.V7020	180	80	110
52.V7025*	180	80	110
52.V7030	200	100	120
52V7035*	200	100	120

Anti-chok buffer  
Impact buffer



\* Med plade. With plate

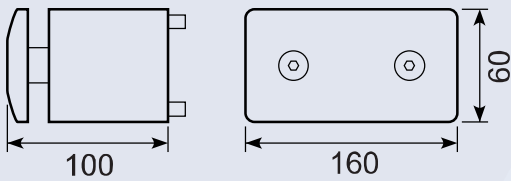

39.171J



Gummibuffer, sort  
Rubber buffer, black

Ø23 x 13 mm

39.175H



Gummibuffer, NR, hvid  
Rubber buffer, NR, white

Ø39 x 32 mm

39.175J



Gummibuffer, sort  
Rubber buffer, black

Ø39 x 32 mm

39.AV50

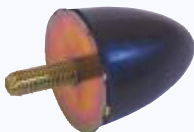

Gummibuffer, konisk  
SBR, sh. 65 A  
Rubber buffer, conical  
SBR, Sh. 65 A

Ø50 x 55 mm  
M10 x 27 mm  
gevind/thread

● Godt køb / best buy

### 39.2F3030



**Vibrationsdæmper, indvendig M8 begge sider, sh. 65 A** Ø30 x 30 mm

Vibration damper, M8 internal both sides, Sh. 65 A

### 39.2F4030

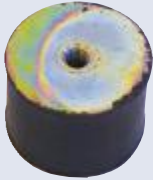

**Vibrationsdæmper, indvendig M8 gevind begge sider, sh. 65 A** Ø40 x 30 mm

Vibration damper, M8 internal both sides, Sh. 65 A

### Vibrationsdæmpere

Vare nr.	Shore	Mål, gevind
		mm
39.M2515	m3020	65 M6 x 18
39.M3020	m3020	65 M8 x 23
39.M3020B	m3020B	45A M8 x 23
39.M3030B	m3030	45 M8 x 23
39.M4030B	m4038	55 M8 x 23

#### Vibrationsdæmper m3020, SH.65

Unigum rubber buffer M3020, Sh. 65 A

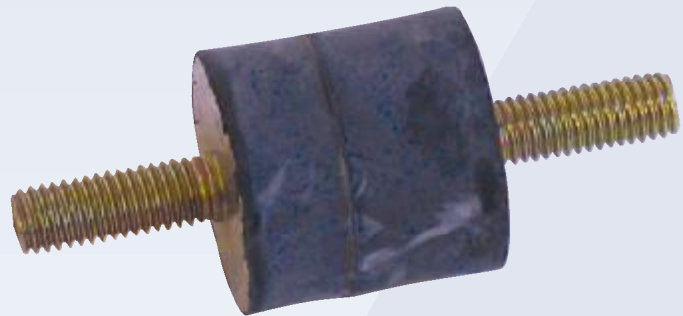

### 39.627

#### Gummibuffer

L: 200 mm

Rubber buffer



### 39.631

#### med lærred med 4 huller center 60 mm

110 x 125 x 40 mm

Rubber buffer, SBR black, Sh. 75 A, with linen, 4 holes, centre 60 mm

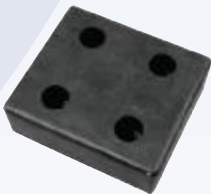

### 39.632J

#### Gummibuffer, oval med 2 huller, sort

74 x 38 mm  
Center 50 mm  
Højde 24 mm

Rubber buffer, oval with 2 holes, black

Centre 50 mm  
Height 24 mm



● Godt køb / best buy



39.634

**Buffer med stålskiver og stålhylser til 16mm bolt 3 huller, EPDM kvalitet**

400 x 80 mm  
Højde: 70 mm

Buffer with steel washers and steel casing for 16 mm bolt, 3 holes, EPDM quality.



39.635

**Buffer, vulkaniseret ny gummi med vulkaniserede stålskiver**

500 x 250 x 90 mm

Buffer, vulcanized new rubber with vulcanized steel washers



39.636

**Buffer, vulkaniseret ny gummi med vulkaniserede stålskiver**

500 x 250 x 140 mm

Buffer, vulcanized new rubber with vulcanized steel washers



39.637

**Buffer**

125 x 40 x 40 mm

Vehicle bumper



39.638

**Buffer**

200 x 50 x 50 mm

Vehicle bumper

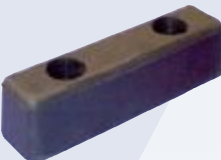

39.620

**Gummibuffer indlagt skive 600 g pr. stk. se varenummer 39.638**

200 x 53 x 55 mm

Rubber buffer with washer, 600 g each refer to article No. 39.638



39.623J

**Gummibuffer lidt konisk, Ø 10 mm huller**

196 x 84 x 63 mm

Rubber buffer, slightly conical, with Ø10 mm holes

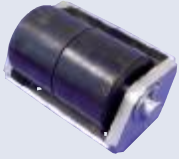

● Godt køb / best buy

**39.625****Gummirullefender, galvaniseret.**

Rubber bumper roll fender, galvanized

195 x 113 mm  
Rullediameter Ø100  
Bolthul Ø13 mmRoll diameter Ø100  
Bolt hole Ø13 mm**39.626J****Gummibuffer**

Rubber buffer

125 x 43 x 40 mm

**39.180****Gummifod Ø 120 mm for liftarme  
SBR 80 sh. A, sort**Rubber pads Ø 120 mm for lift stabilizers  
SBR, Sh. 80 A, blackIndvendig Ø108 mm  
Højde: 26 mmInternal Ø108 mm  
Height: 26 mm**39.181****Gummifod Ø 120 mm for liftarme  
SBR 75 sh. A, sort**Rubber pads Ø 120 mm for lift stabilizers  
SBR, Sh. 75 A, blackIndvendig Ø110 mm  
Højde: 26 mmInternal Ø110 mm  
Height: 26 mm**39.182****Gummifod Ø 145 mm for liftarme  
SBR, 75 sh. A, sort**Rubber pads Ø 145 mm for lift stabilizers  
SBR, Sh. 75 A, blackIndvendig Ø12 mm  
Højde: 24 mmInternal Ø12 mm  
Height: 24 mm**39.183****Gummifod Ø 145 mm for liftarme  
SBR, 80 sh. A, sort**Rubber pads Ø 145 mm for lift stabilizers  
SBR, Sh. 80 A, blackIndvendig højde:  
26 mmInternal height: 26  
mm**39.184****Gummiklods for liftarme  
SBR, 75 SH. A, sort**Rubber pads for lift stabilizers  
SBR, Sh. 75 A, black

160 x 120 x 20 mm

Godt køb / best buy

**39.185**



**Gummiklods for liftarme  
SBR, 75 SH. A, sort**

160 x 120 x 35 mm

Rubber pads for lift stabilizers  
SBR, Sh. 75 A, black

**39.186**



**Gummiklods for liftarme  
SBR, 75 SH. A, sort**

160 x 120 x 120 mm

Rubber pads for lift stabilizers  
SBR, Sh. 75 A, black

**39.187**



**Gummiklods for liftarme  
SBR, 75 SH. A, sort**

180 x 60 x 100 mm

Rubber pads for lift stabilizers  
SBR, Sh. 75 A, black

## Læsebagsmæksprofiler og Alu. lister / Special profiles for tailboard and alu. profiles

### Læsebagsmæksprofiler

Vare nr.	Mål mm	Fod mm	Rulle længde meter
30.330S			
30.331	39 x 48,5	23,5 x 2,5	25
30.331/1500	39 x 48,5	23,5 x 2,5	1,5
30.331/1850	39 x 48,5	23,5 x 2,5	1,85
30.331/2200	39 x 48,5	23,5 x 2,5	2,2
30.331/2600	39 x 48,5	23,5 x 2,5	2,6

Læsebagsmæksprofil m. læbe  
Hårdhed shore 65° EPDM

Rubber profile with lip for loading tailboard  
Shore 65° EPDM



### 41.671

Aluminiumsfodliste  
Aluminium skirting board



A: 8 mm  
B: 30 mm  
C: 26 mm  
D: 4 mm  
E: 12 mm  
Længde/Length:  
1 meter/metre

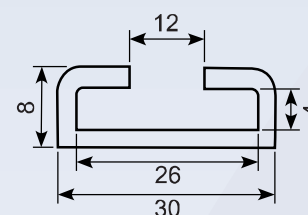

### 41.672A

Aluliste til f.eks. bagsmæksprofil

Aluminium skirting board



A: 8 mm  
B: 30 mm  
C: 26 mm  
D: 4 mm  
E: 12 mm  
Længde/Length:  
2 meter/metre

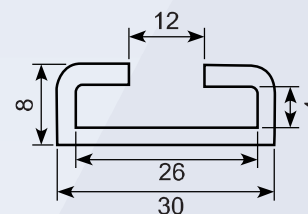

### 41.675A

Aluliste til f.eks. bagsmæksprofil

Aluminium skirting board



A: 8 mm  
B: 30 mm  
C: 26 mm  
D: 4 mm  
E: 12 mm  
Længde/Length:  
5,2 meter/metre

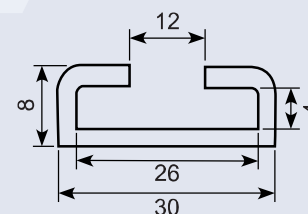

### 30.7649

D-tætningsprofil  
Hårdhed shore 60°, EPDM

D-seal  
Shore 60°, EPDM



### 30.7933

H-profil  
Hårdhed shore 70°, EPDM

H-profile  
Shore 70°, EPDM



Rullelængde 25  
meter

Roll length 25 metre

30.8469



Læssebagsmæksprofil med vandnæse  
Hårdhed shore 67°, EPDM

Rullelængde 8  
meter

Profile with water lip for loading tailboard  
Shore 67°, EPDM

Roll length 8 metre

30.6648



Skørteprofil  
Hårdhed shore 60°/65°, PVC  
Sort

Rubber profile  
Shore 60°/65°, PVC  
Black

30.2151



Skørteprofi i ruller a 14 meter  
Hvid PVC

PVC profile, white in 14 meter rolls

30.2566

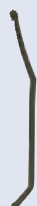

Skørteprofil, 64 meter  
Hårdhed shore 60°/65°, PVC  
Sort

PVC profile, 64 meter, black  
Shore 60°/65°

30.314S



Gummiprofil  
Hårdhed shore 60°/65°, EPDM

Rubber profile  
Shore 60°/65°, EPDM

30.333



L-profil  
Hårdhed shore 75°, EPDM  
Rullelængde 2,6 meter

L-profile  
Shore 75°, EPDM  
Length 2,6 metres

41.333S



Stålprofil til montering af gummiprofil  
30.333

Længde: 2,6 meter

Steel profile for mounting of rubber profile  
30.333

Length: 2,6 metre

41.116

Aluminiumsprofil

Aluminium profile

A: 4 mm  
B: 16 mm  
Længde: 6 meter  
Length: 6 metre

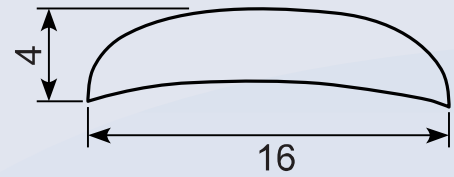

41.3720058

Aluprofil, samleliste til 4 mm plade

Edging section, aluminium for 4 mm plate

A: 1,5 mm  
B: 48,5 mm  
C: 4 mm  
D: 14,5 mm  
Længde/Length: 5 meter/metre

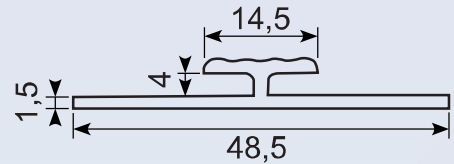

41.372P

Aluminiumsliste, poleret.

Edging section, polished

A: 25 mm  
B: 2 mm  
C: 5 mm  
D: 6 mm  
Længde/Length: 5 meter/metre

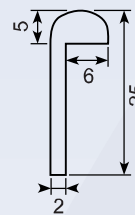

41.376P

Aluminiumsliste, poleret.

Edging section, polished

A: 24 mm  
B: 14 mm  
C: 2 mm  
D: 3 mm  
Længde/Length: 5 meter/metre

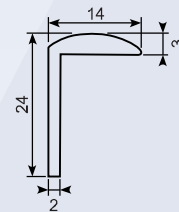
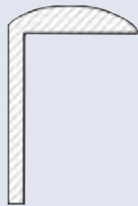

41.406

Vandrende, upoleret

Drip moulding, unpolished

A: 23,5 mm  
B: 18 mm  
Længde/Length: 5 meter/metre

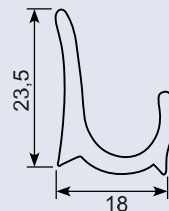

41.611P

Aluminiumsliste, poleret

Edging section, polished

A: 6,2 mm  
B: 25 mm  
Spor/Track: 3 mm  
Længde/Length: 5 meter/metre

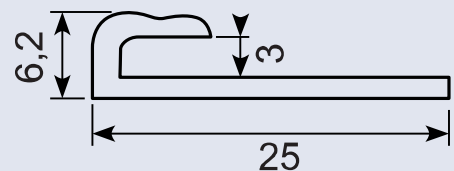

42.420

Pynteliste, excl. indlæg

Trim strip, exclusive insertion

A: 4,7 mm  
B: 20,5 mm  
Længde/Length: 5 meter/metre

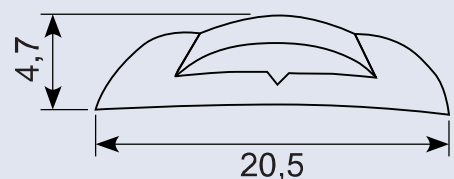

45.208

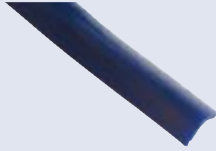

Indlægsliste, blå

Insertion, blue

A: 2,7 mm  
B: 12,3 mm  
C: 4,7 mm  
D: 2 mm

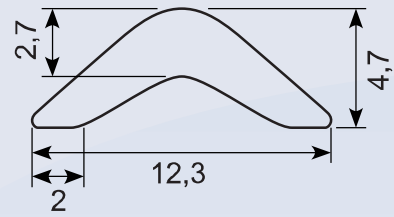

45.205S

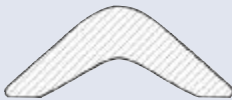

Indlægsliste, alu/sølvgrå, mat

Insertion, silvery/alu, dull finish

A: 2,7 mm  
B: 12,3 mm  
C: 4,7 mm  
D: 2 mm

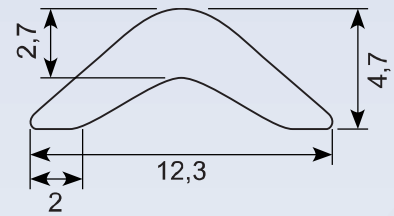

45.209B



Indlægsliste, sort

Insertion, black

A: 2,7 mm  
B: 12,3 mm  
C: 4,7 mm  
D: 2 mm

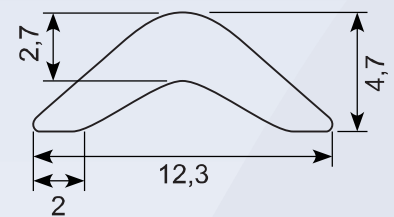

45.201B



Indlægsliste, sølvgrå

Insertion, silvery

A: 2,7 mm  
B: 12,3 mm  
C: 4,7 mm  
D: 2 mm

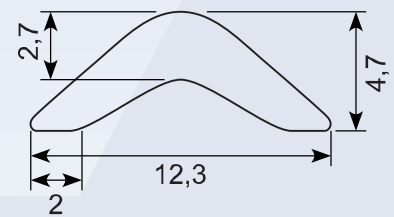

45.205B



Indlægsliste, rød

Insertion, red

A: 2,7 mm  
B: 12,3 mm  
C: 4,7 mm  
D: 2 mm

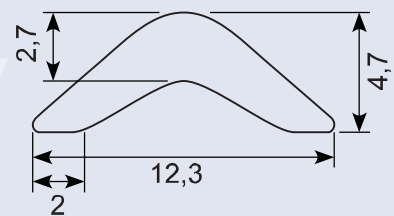

50.083030



Bagdørsprofil, co-extruderet, hvid/sort med 4 bløde læber, længde 5 meter

Rear door profile, co-extruded, black/white with 4 soft lips, length of 5 metre

A: 18 mm  
B: 18 mm  
C: 14 mm  
D: 26 mm  
E: 3 mm

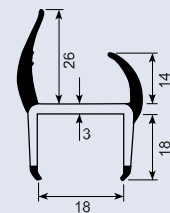

50.083033

Co-extruderet 19 mm  
Farve: lysegrå/sorte læber

Længde: 5 meter

Co-extruded profile 19 mm, light grey/black lips



● Godt køb / best buy

50.083040



Bagdørsprofil, co-extruderet, hvid/sort med 4 bløde læber, længde 5 meter

Rear door profile, co-extruded, white/black with 4 soft lips, length of 5 metre

A: 18 mm  
B: 21 mm  
C: 14 mm  
D: 26 mm  
E: 3 mm

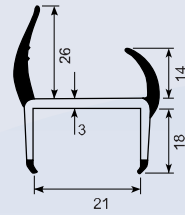

50.083050

Co-extruderet 30 mm  
Farve: hvid/sorte læber

Længde: 5 meter

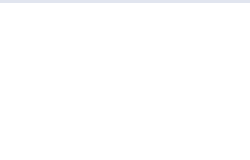

Co-extruded profile 30 mm, white/black lips

54.710700

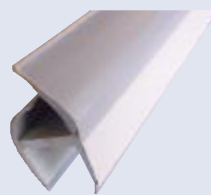

Co-extruderet profil 20 mm, med lysegrå/grå læber, længde 3 meter

Co-extruded profile 20 mm, with light grey/grey lips, length of 3 metre

A: 17,5 mm  
B: 20 mm  
C: 14 mm  
D: 25,5 mm

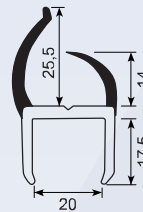

54.710720

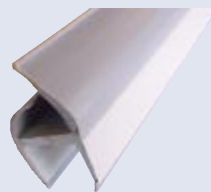

Co-extruderet profil 25 mm, lysegrå/grå læber, længde 3 meter

Co-extruded profile 25 mm, light grey/grey lips, length of 3 metre

A: 18 mm  
B: 27 mm  
C: 14 mm  
D: 29 mm

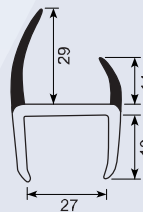

54.710730

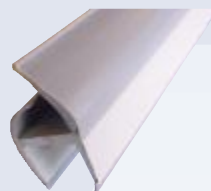

Co-extruderet profil 30 mm, lysegrå/grå læber, længde 3 meter

Co-extruded profile 30 mm, light grey/grey lips, length of 3 metre

A: 20,8 mm  
B: 28 mm  
C: 14 mm  
D: 29 mm

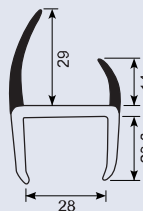

54.710750

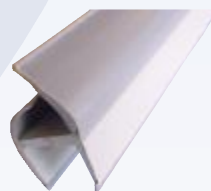

Co-extruderet profil 40 mm, lysegrå/grå læber, længde 3 meter

Co-extruded profile 40 mm, light grey/grey lips, length of 3 metre

A: 20 mm  
B: 40 mm  
C: 30 mm  
D: 14 mm

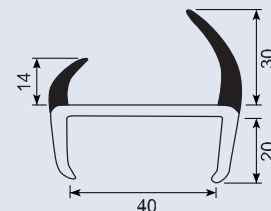

54.710770

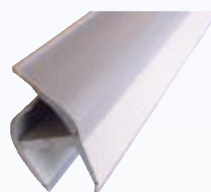

Co-extruderet profil 55 mm, lysegrå/grå læber, længde 3 meter

Co-extruded profile 55 mm, light grey/grey lips, length of 3 metre

A: 24 mm  
B: 55 mm  
C: 33 mm  
D: 14 mm

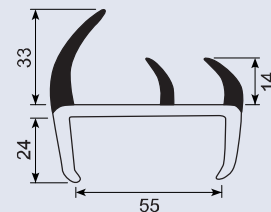

● Godt køb / best buy



## 54.710780

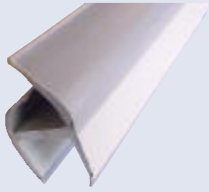

Co-extruderet profil 85 mm, lysegrå/grå læber, længde 3 meter  
Co-extruded profile 85 mm, light grey/grey lips, length of 3 metre

A: 26,5 mm  
B: 84 mm  
C: 30 mm  
D: 13,5 mm  
E: 16 mm

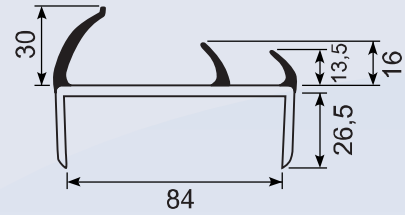

## 50.020010

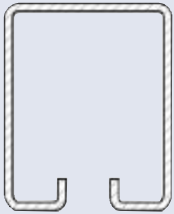

Galvaniseret C-skinne  
C-rail, zinc-plated

A: 35 mm  
B: 30 mm  
C: 7 mm  
D: 5 mm  
E: 1,9 mm  
Længde: 6 meter

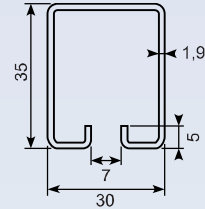

## 50.020020

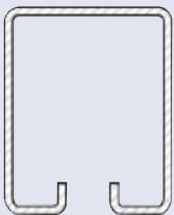

Galvaniseret C-skinne  
C-rail, zinc-plated

A: 50 mm  
B: 40 mm  
C: 11 mm  
D: 5 mm  
E: 2 mm  
Længde: 6 meter

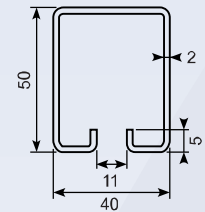

## 50.022010



Ø44 mm jernrulle med leje.  
Til skinne 50.020020

Steel roller with bearing  
For rail 50.020020

## 50.022020



Ø30 mm jernrulle med leje  
Til skinne 50.020010

Steel roller with bearing  
For rail 50.020010

## 50.024020



Ø30 mm jernrulle med leje.  
Til skinne 50.020010

Steel roller with bearing  
For rail 50.020010

## 50.024050



Ø44 mm jernrulle med leje.  
Til skinne 50.020020

Steel roller with bearing.  
For rail 50.020020

● Godt køb / best buy

Centraflex

Vare nr.	A	B	C	D	L
	mm	mm	mm	mm	mm
20.6020	29	3,3	24	16	2000
20.6025	29	3,3	24	16	2500
20.6120	29	3,3	24	16	2000
20.6125	29	3,3	24	16	2500
20.6130	29	3,3	24	16	3000

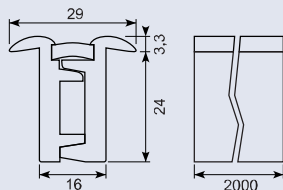

Centraflex. Vandtæt stanghængsel med PU-kerne og kunststof flanger. Tillader 180 gr. åbning. Stor styrke og høj elasticitet. Sort finish.

Weather-proof continuous hinge with PU-core and synthetic flanges. 165° opening, 28 mm face. High strength and excellent flexibility. Black finish.

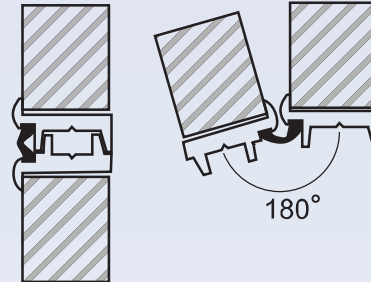
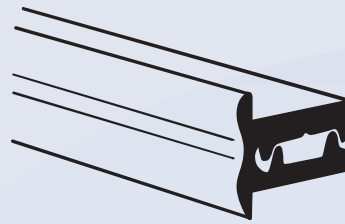

Poly-all

Vare nr.	B	L
	mm	mm
54.261100	24	2400
54.261120	24	2700
54.261130	24	4000
54.261700	29	2400
54.261720	29	2700
54.261740	29	3000
54.261780	29	4000



Poly-all.

Vandtæt stanghængsel med PU kerne og aluminium flanger. Tillader 180 gr. åbning.

Stor styrke og høj elasticitet. Forboret med 5mm. huller i flange. Hulafstend : 200mm. Aluminium finish.

Poliall continuous hinge

Poly-all

Vare nr.	B	L
	mm	mm
54.261700J	29	2400
54.261720J	29	2700
54.261740J	29	3000
54.261780J	29	4000



Poly-all Sindby

Poly-all Sindby continuous hinge

Gasfjedre

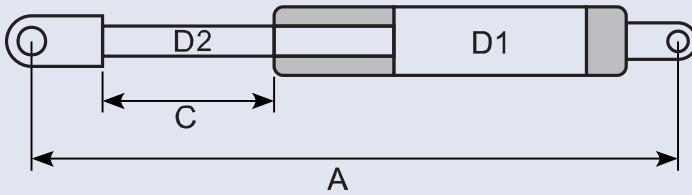

Vare nr.	A Totallængde	C Slaglængde	D2 Stempel stang	D1 Cylinder	Styrke
	mm	mm	mm	mm	Nm
19.2801	285	105	8	19	150
19.2802	354	140	10	22	520
19.2804	385	150	8	19	150
19.2806	616	271	8	19	290
19.2810	445	150	10	22	250
19.2812	445	150	10	22	400
19.2814	445	150	10	22	650
19.2820	503	200	10	22	250
19.28201*	521	200	10	22	150
19.28205	503	200	10	22	350
19.2821	503	200	10	22	400
19.2822	503	200	10	22	500
19.28221*	521	200	10	22	500
19.2824	503	200	10	22	650
19.2826	503	200	10	22	750
19.2828	503	200	10	22	1000
19.28291*	598	250	10	22	150
19.28292*	598	250	10	22	250
19.2831	650	250	10	22	250
19.2832	650	250	10	22	500
19.2834	650	250	10	22	750
19.2836	650	250	10	22	1000
19.2844	750	300	14	28	750
19.2846	750	300	14	28	1000
19.2848	750	300	14	28	1250
19.2850	750	300	14	28	1500
19.28501	750	300	14	28	1750
19.2851	750	300	14	28	2000
19.2844X	692	300	14	28	750
19.2846X	692	300	14	28	1000
19.2848X	692	300	14	28	1250
19.2850X	692	300	14	28	1500
19.28501X	692	300	14	28	1750
19.2851X	692	300	14	28	2000

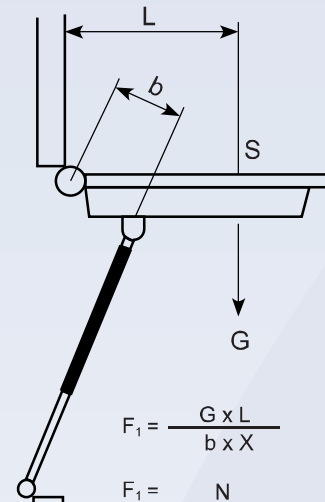

S = Klappens tyngdepunkt  
 G = Klappens vægt i Nm (kg x 10)  
 B = Afstand fra gasfjeder til omd. punkt  
 X = Antal fjedre (Normalt 2 pr. klap)  
 F1 = Gasfjederens tryk i Nm

**Vejledning i montering**

For at sikre den optimale placering tilbyder vi at foretage beregningen.

For at lave beregningen skal vi bruge følgende:

- Klappens totallængde
- Tyngdepunkt
- Vægt
- Anvendes 1 eller 2 gasfjedre?

Der henvises i øvrigt til den viste beregningsformel.

19.2865

**U-beslag til gasfjederøjer. Galvaniseret.**

U-fittings for gas spring, zinc-plated



- A: 69 mm
- B: 51 mm
- C: 40 mm
- D: 29 mm
- E: Ø6,5 mm
- F: 17 mm
- G: 18 mm
- H: 13 mm
- I: 2,5 mm
- J: Ø8 mm

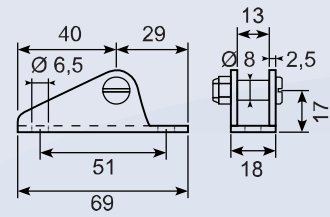

19.28656

**Centerbeslag til gasfjederøjer. Galvaniseret.**

Bracket for hinge eyes, zinc-plated



- A: 41 mm
- B: 44 mm
- C: 5,2 mm
- D: 9 mm
- E: 25 mm
- F: 35 mm

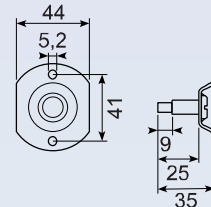

19.320440

**Gasfjeder befæstigelse - Ø 8 mm tap Sort-elox aluminium**

Gas spring fixing, Ø8 mm pin anodized aluminium Black



- A: 80 mm
- B: 35 mm
- C: 65 mm
- D: 20 mm
- E: 46 mm
- F: Ø8 mm
- G: Ø6,5 mm

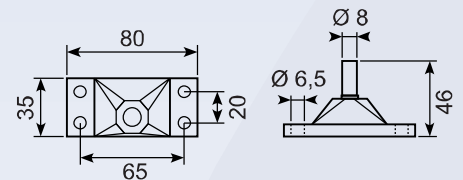

19.320460

**Gasfjeder U-befæstigelse - Ø 8 mm tap Sort-elox aluminium**

Gas spring fixing, Ø8 mm pin anodized aluminium Black



- A: 80 mm
- B: 33 mm
- C: 19 mm
- D: 32 mm
- E: 60 mm
- F: Ø8 mm
- G: Ø6,5 mm

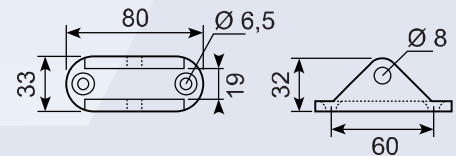

19.3880-P100

**Gasfjeder U-befæstigelse. Ø 8 mm galvaniseret tap. Sort polyamid.**

U-bracket for gas spring, Ø8 mm, zinc-plated pin, black polyamide



- A: 62 mm
- B: 21,5 mm
- C: 40,5 mm
- D: Ø8 mm
- E: 5,5 mm
- F: 19 mm
- G: 10 mm
- H: 6,5 mm
- I: Ø5 mm
- J: R11

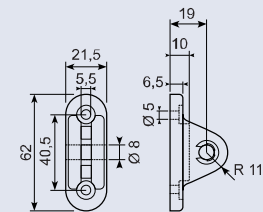

19.3880-P101

**Gasfjeder befæstigelse. Ø8 mm galvaniseret tap. Sort polyamid.**

Bracket for gas springs, Ø8 mm, zinc-plated pin, black polyamide.



- A: 61,5 mm
- B: 29 mm
- C: 42,5 mm
- D: 13 mm
- E: 8 mm
- F: Ø4,5 mm
- G: 7 mm
- H: 26,5 mm
- I: Ø8 mm
- J: 13,5 mm
- K: 4 mm
- L:
- M: Ø15,5 mm
- N: Ø8 mm

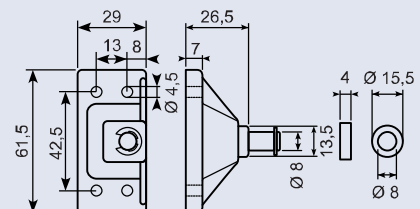

### 19.3880BA0

#### Låsekop for beslag 19.3880BA1 & 19.3880BA2



Locking bucket for gas spring fittings 19.3880BA1 and 19.3880BA2

A: 7 mm  
B: Ø16 mm  
C: 2 mm  
D: Ø6 mm

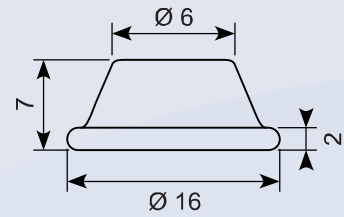

### 19.3880BA1

#### Galvaniseret beslag for gasfjedre m. øje Ø 8 mm



Zinc-plated bracket for gas springs with eye Ø8 mm

A: 52 mm  
B: 43,5 mm  
C: 32 mm  
D: 9,5 mm  
E: 10 mm  
F: 17 mm  
G: 45°  
H: 28 mm  
I: 15 mm  
J: 3 mm  
K: Ø7,2 mm  
L: Ø14 mm  
M: Ø6 mm  
N: Ø8 mm  
\* forsænkning Ø5,5 mm x 90°

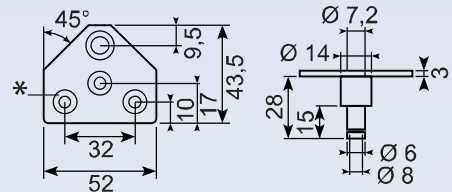

### 19.3880BA2

#### Galvaniseret beslag for gasfjedre m. kugleled (øje Ø8 mm).

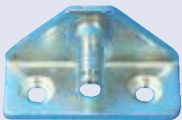

Zinc-plated bracket for gas springs with ball joint (eye Ø8 mm)

A: 14,5 mm  
B: 9,5 mm  
C: 45°  
D: 3 mm  
E: 21 mm  
F: 15 mm  
G: Ø10,5 mm  
H: 26 mm  
I: 16 mm  
J: 32 mm  
K: Ø8 mm  
L: Ø6 mm  
M: Ø14 mm  
N: Ø5,5 mm

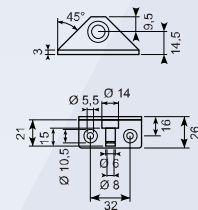

### 19.3880BA3

#### Galvaniseret vinkelbeslag for gasfjedre m. kugle Ø10 mm

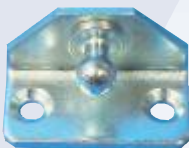

Zinc-plated angle hinge for gas springs with ball Ø10 mm

A: 14,5 mm  
B: 9,5 mm  
C: 45°  
D: 3 mm  
E: 32 mm  
F: 16 mm

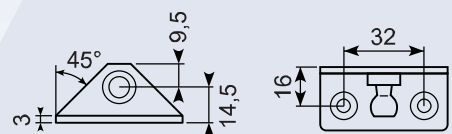

### 19.3880BA4

#### Galvaniseret vinkelbeslag for gasfjedre m. kugleled ( kugle Ø 10 mm )



Zinc-plated angle hinge for gas springs with ball joint (ball Ø10 mm)

A: 52 mm  
B: 43,5 mm  
C: 32 mm  
D: 9,5 mm  
E: 10 mm  
F: 17 mm  
G: 45°  
H: 18 mm  
I: kugle Ø10 mm  
\* forsænkning Ø5,5 mm x 90°

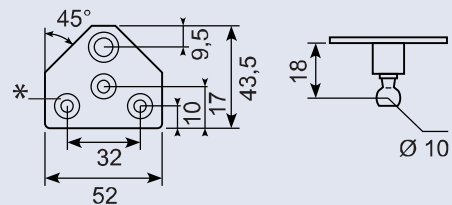

57.693



**Nødhammer med holder, genbrugsplast, uden plombe**

Emergency breaker arm with keeper

57.PW008A

**Nødhammer med stålindlæg**

Emergency breaker arm

57.695



**Nødhammer u. beslag. Uden plombe.**

Emergency breaker arm, no keeper

A: 151 mm  
B: 21 mm  
C: 56 mm  
D: 64 mm  
E: 11 mm  
F: 70,5 mm  
G: 77 mm  
H: 9 mm  
I: 20 mm  
J: Ø2 mm  
K: Ø3,6 mm  
L: Ø8,8 mm

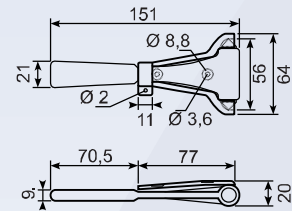

57.PW008

**Nødhammer uden beslag**

Red hammer, no keeper

57.696



**Beslag til nødhammer**

Holder for emergency breaker arm

57.5772



**Nødhammer med kabel 0,8 m. Uden plombe.**

Emergency breaker arm with cable 0.8 m

A: 152 mm  
B: 62 mm  
C: 42 mm  
D: Ø68 mm  
E: 40 mm  
F: 3 mm

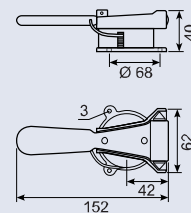

57.690

**Nødhammer med holder og kniv. Uden plombe.**

Emergency breaker arm with seat belt cutter

A: 39,2 mm  
B: 41,5 mm  
C: Ø4 mm  
D: 3 mm

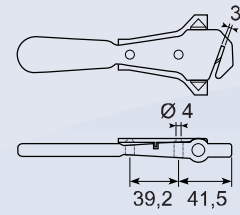

57.697

**Stor nødhammer**

Emergency breaker arm, large

A: 185 mm  
B: 87 mm  
C: 108 mm  
D: 62 mm  
E: 12 mm

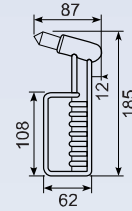

57.698

**Beslag til nødhammer 57.697**

Holder for emergency breaker arm

A: 81 mm  
B: 79 mm  
C: 57,5 mm  
D: 54,2 mm  
E: 42 mm  
F: 22 mm  
G: 5,5 mm  
H: 46,4 mm  
I: 7,5 mm  
J: 25 mm

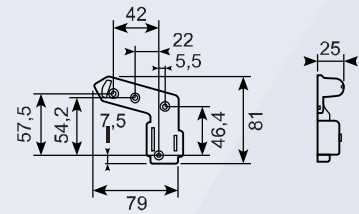

## Tagluger og skydevinduer / Roof hatches and sliding windows

04.1382



Skydevindue, horisontal

500 x 400 mm

Sliding window, horizontal

04.1382A



Skydevindue, vertikal

500 x 400 mm

Sliding window, vertical

04.7915



Skydevindue, horisontal

600 x 300 mm

Sliding window, horizontal

04.7915A



Skydevindue, vertikal

600 x 500 mm

Sliding window, vertical

29.140

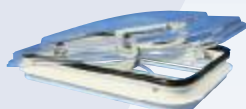

Tagluge med gitter, klart glas

350 x 500 mm

Roof hatch with lattice, clear glass

29.140A

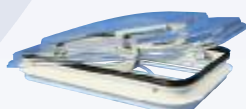

Klart glas til 29.140

Clear glass for 29.140



## 29.141

**Tagluge med gitter, røgfarvet**

350 x 500 mm

Roof hatch with lattice, smoke-tinted glass



## 29.141A

**Røgfarvet glas til 29.141**

Smoke-tinted glass for 29.141

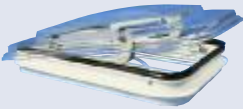

## 52.109159



**Patriot 15,000 12V. Off-road maks. trækkevne 6800kg. 27.4m. wire, 4 vejs lineleder, 3.5m. kabelbetjening. Fåes også i 24V.**

617 x 215 x 279 mm  
Vægt: 54 kg.

Patriot 15.000 winch 12V, max. 6800 kg

## 52.109161



**Patriot profile 6000 spil 12V off-road. Maks. trækkevne 2720kg. 30,5m wire. 3,5 meter kabelbetjening. Fåes også i 24V.**

575 x 168 x 155 mm  
Vægt: 29,5 kg.

Patriot profile 6.000 winch, 12V

## 52.109194



**Patriot profile 12000 spil 12V off-road. Maks. trækkevne 5440kg. 38,1 m wire. Fåes også i 24 V.**

568 x 198 x 226 mm.  
Vægt: 47 kg.

Patriot profile 12.000 12V, max. 5440 kg

## 52.110262



**ATV 3000 12V maks. trækkevne 1360kg. 15m. wire, 4 vejs lineleder, trådløs fjernbetjening**

335 x 114 x 123 mm  
Vægt: 9,5 kg.

ATV 3000 R winch 12V

## 52.110264



**ATV 3000 R spil 12V. Maks. trækkevne 1360kg. 15m wire.**

335 x 114 x 123 mm  
Vægt: 9,5 kg.

ATV 3000 R winch 12V

## 52.112162



**RE 12,000 12 V off-road maks. trækkevne 5440 kg. 30.5 m. wire, 4 vejs lineleder m. 3.5 m. kabel betjening. Fåes også i 24V.**

558 x 273 x 260 mm  
Vægt: 61 kg

RE 12.000 winch 12V

## 52.115000

**ATV 2500 12V maks. trækkevne 1133kg. 15m. wire, 4 vejs lineleder, trådløs fjernbetjening.**

335 x 114 x 123 mm  
Vægt: 9,5 kg.



ATV 2500 R winch 12V

## 52.115004

**ATV 2500 el-spil 12V maks. trækkevne 1133kg. Kabelbetjening. 15m wire.**

335 x 114 x 123 mm  
Vægt: 9,5 kg.



ATV 2500 winch 12V

## 52.123001

**RPH 8000 Hydralisk spil. Maks. trækkevne 3620 kg. Manuel skift.**

Winch RPH8-AUCM, A-rot, manual shift

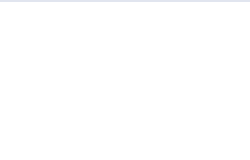

## 52.251014

**Taljeblok til el-spil. Maks. kapacitet 7200kg.**

Snatch block, max. 7200 kg



## 52.251043

**Quick mount platform til QM el-spil**

Quick mount platform



## 52.251051

**Kabelsæt til QM el-spil**

Wiring kit QM



## 52.251053

**Batterikabel til el-spil**

Kit-quick connect battery lead

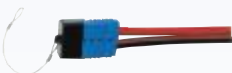

52.251076

**ATV monteringskit til ATV spil.**

ATV quick mount kit



52.251120

**Wire f/el-spil 30, 48 m. 5/16. ATV og Offroad el-spil.**

Cable with hook 48 m 5/16



52.251183

**4 vejs lineleder**

Roller fairlead

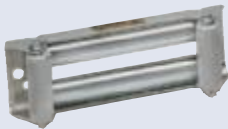

52.251200

**Trådløs fjernbetjening kan leveres til alle typer spil rækkevidde ca. 15 m.**

Wireless remote-ft



52.251243

**Taljeblok til el-spil. Maks. kapacitet 3600 kg.**

Snatch block, max. 3600 kg



52.251245

**Taljeblok til el-spil. Maks. kapacitet 13600 kg.**

Snatch block, max. 13600 kg



52.251264

**Neopreneovertræk til ATV spil. 2 mm vejrbestandig neoprene**

Winch cover, neoprene, for ATV



**52.298007**



**Monteringskit til Honda 500 ATV el-spil**

Honda mounting kit 500

**52.298041**



**Monteringskit til Honda 600 ATV el-spil**

Honda mounting kit 600

**52.C62001**



**22.5" standardkapsel, for**  
22.5" standard wheel cap, front

**52.C62002**



**22.5" standardkapsel, bag**  
22.5" standard wheel cap, rear

**52.C62003**



**19.5" standardkapsel, for**  
19.5" standard wheel cap, front

**52.C62004**



**19.5" standardkapsel, bag**  
19.5" standard wheel cap, rear

**52.C62005**



**17.5" standardkapsel, for**  
17.5" standard wheel cap, front

**52.C62006**



**17.5" standardkapsel, bag**  
17.5" standard wheel cap, rear

#### 52.C62011



**22.5" De-luxe hjulkapsel, for**  
22.5" De-luxe wheel cap, front

#### 52.C62012



**22.5" De-luxe hjulkapsel, bag**  
22.5" De-luxe wheel cap, rear

#### 52.C62014



**22.5" fælgbeklædning med små møtrikker**  
22.5" rim cover with small nuts

#### 52.C62015



**22.5" fælgbeklædning med stor midterdel**  
22.5" rim cover with large central part

#### 52.C62016



**22.5" fælgring til brede forhjul**  
22.5" rim ring for wide front wheels

#### 52.C62017



**22.5" 10-huls navring med lukket midterdel**  
22.5" 10-hole hub ring with closed centre part

#### 52.C62018



**22.5" 10-huls navring med åben midterdel**  
22.5" 10-hole hub ring with open centre part

#### 52.C62019



#### Møtrikkapsler i 32mm

Nut cap 32 mm

#### 52.C62020



#### Møtrikkapsler i 33mm

Nut cap 33 mm

#### 52.C62028



#### 19.5" De-luxe hjulkapsel, bag

19.5" De-luxe wheel cap, rear

#### 52.C62029



#### 22.5" fælgbeklædning uden midterdel

22.5" rim cover without central part

#### 52.C62030



#### 22.5" wheel-liner til den yderste del af fælgen

22.5" wheel liner for the outermost part of rim

#### 52.C62031



#### 19.5" De-luxe hjulkapsel, for

19.5" De-luxe wheel cap, front

#### 52.C62033



#### 17.5" De-luxe hjulkapsel, for

17.5 De-luxe wheel cap, front



**52.C62034**



**17.5" De-luxe hjulkapsel, bag**

17.5 De-luxe wheel cap, rear

**52.C62040**



**15" forkapsel med universal cliplås**  
**Passer ikke til Iveco Daily**

15" front cap with universal clip lock

**52.C62041**



**15" bagkapsel med universal cliplås**  
**Passer ikke til Iveco Daily**

15" rear cap with universal clip lock

**52.C62042**



**16" forkapsel med universal cliplås**  
**Passer ikke til Iveco Daily**

16" front cap with universal clip lock

**52.C62043**



**16" bagkapsel med universal cliplås**  
**Passer ikke til Iveco Daily**

16" rear cap with universal clip lock

50.281

**Orange lygteglas, Ø 71 mm**

Lamp glass for incandescent lamp R5W, amber/yellow, Ø 71 mm



50.282

**Rødt lygteglas, Ø 71 mm**

Lamp glass for incandescent lamp R5W, red, Ø 71 mm



50.283

**Hvidt lygteglas, Ø 71 mm**

Lamp glass for incandescent lamp R5W, white, Ø 71 mm



50.283X

**Blænddæksel, sort kunststof, Ø 71 mm**

Blind cover, black synthetic material, Ø 71 mm



50.284

**Lampefatning, dobbelt R5W for glødelampe, hvidt kunststof**

Lampholder/double socket R5W for incandescent lamp, white synthetic material



50.285

**Lygtearm, kort, lige, gummi til Ø 71 mm lamper**

Rubber arm, short, for incandescent lamp/diode lamp, for Ø 71 mm lamp



50.286



**Lygtearm, lang vinkel, gummi til Ø 71 mm lamper**

Rubber arm, long, for incandescent lamp/  
diode lamp for Ø 71 mm lamp

50.287



**Lygtefod, gummi til Ø 71 mm lamper**

Rubber lighting foot for incandescent lamp/  
diode lamp for Ø 71 mm lamp

50.288



**Rød lygte, 1.2 W, 24 V, med 5 m kabel,  
Max. lysstyrke for baglygten er (12  
candela), Ø 7 mm**

Red diode lamp 1.2 W, 24 V with 5 m  
cable, rear parking light. Max. luminosity 12  
Candela, Ø 7 mm

50.289



**Hvid lygte, 1.2 W, 24 V med 5 m kabel,  
lygten har begrænset styrke for ikke at  
blænde, den har 4 dioder. Ø 7 mm**

Diode lamp 1.2 W, 24 V with 5 m cable,  
white rear parking light. Limited power, does  
not dazzle, Ø 7 mm.

50.290



**Orange lygte, 1.2 W, 24 V med 5 m kabel,  
orange lygte, er dobbelt så lysstærk  
som traditionelle glødetrædslygter  
(17 candela), Ø 7 mm**

Diode lamp 1.2 W, 24 V with 5 m cable, side  
light amber, luminous 17 candela,  
Ø 7 mm

## 50.10201

**Grå PVC toiletlås**

Grey PVC toilet lock



## 50.10202

**Alu. toiletlås til indbygning.  
Komplet sæt.**

Alu toilet lock for mounting. Complete set



## 50.9750

**Lysegrå plasthåndtag, komplet m.  
rosetter og skruer**

Plastic handle set, light grey

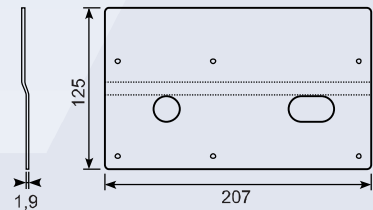

## 50.9576-10

**Sikringsplade til dørlås.  
Rustfri plade med buk, 8 huller, AISI 304  
Højrehængt model**Stainless plate with cover paper, with bend,  
8 holes, AISI 304, right modelA: 207 mm  
B: 125 mm  
C: 1,9 mm

## 50.9576-11

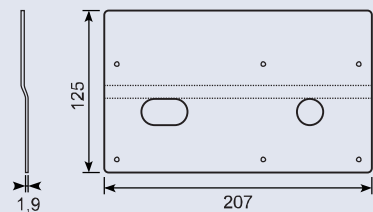
**Sikringsplade til dørlås.  
Rustfri plade med buk, 8 huller, AISI 304  
Venstrehængt model**Stainless plate with cover paper, with bend,  
8 holes, AISI 304, left model.A: 207 mm  
B: 125 mm  
C: 1,9 mm

## 50.9576-12

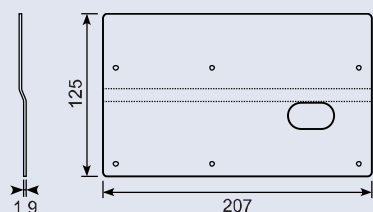
**Sikringsplade til dørlås.  
Rustfri plade med buk, 7 huller, AISI 304  
Højrehængt model**Stainless plate with cover paper, with bend,  
7 holes, AISI 304, right model.A: 207 mm  
B: 125 mm  
C: 1,9 mm

Godt køb / best buy

#### 50.9777-1



**Varmt galv. Skål m. 3 flanger ASTM A653CS**

Hot dip bowl with 3 flange ASTM A653CS (DX51D Z-275)

#### 50.9777-2



**Varmt galv. Bagplade ASTM A653CS**

Hot dip backplate ASTM A653CS (DX51D Z-275)

#### 50.9777-4



**Varmt galv. Skål, dyb, m. 3 flanger ASTM A653CS**

Hot dip bowl, deep with 3 flanges, ASTM A653CS (DX51D Z-275)

#### 50.9777-5



**Varmt galv. Modhold ASTM A653CS**

Hot dip catcher 150 mm, 1,5 mm thick, ASTM A653 CS (DX51D Z-275)

#### 50.9777-6



**Rustfri bagplade**

Stainless backplate (like model 2, but stainless)

#### 50.9777-7



**Rustfri skål m. 3 flanger**

Stainless bowl with 3 flanges

#### 50.9398-1



**Reservenøgle, sæt 2 stk.  
100 forskellige kombinationer**

Spare key set 2 pcs. Combinations must match locks.

 Godt køb / best buy

## 50.9398-2



### Reservepakning

Seal for lock 50.9398

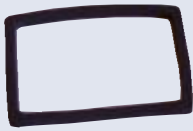

## 50.9398-3

Plastforlænger til flat låsebagplade. Øger dørtykkelse fra 30 mm til 44 mm.

Extension part for flat låsebagplade. Increases door thickness from 30 mm to 44 mm



## 50.9749L



### Galv. Lågeholder, venstre

Zinc-plated stay, left model

Totallængde: 370 mm  
Foldet: 175 mm



## 50.9749R



### Galv. Lågeholder, højre

Zinc-plated stay, right model

Totallængde: 370 mm  
Foldet: 175 mm



## 18.401

### Lågeholder med lås - lille Udskyderarm i galvaniseret jern.

Miniature support stay, locking  
Zinc-plated  
Length: 239/152 mm

A: 152/239 mm  
B: 19 mm  
C: 9 mm  
D: 16 mm  
E: 13 mm  
F: 24 mm  
G: 3,5 mm  
J: 13 mm  
K: 10 mm  
Længde : 239/152 mm

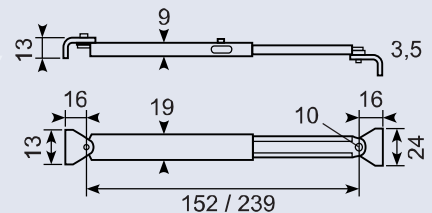

## 18.402

### Lågeholder med lås - stor Udskyderarm - galvaniseret jern

Support stay Star-wheel release  
Mild steel throughout  
Length: 290/495 mm

A: 290/495 mm  
B: 25 mm  
C: 12 mm  
D: 28 mm  
E: 35 mm  
F: 57 mm  
G: 14 mm  
H: Ø9 mm  
I: Ø6 mm  
Længde : 290/495 mm

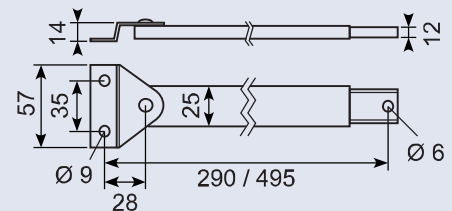

Godt køb / best buy

50.10565



Luftventil i ABS plast.  
-50°C til +80°C

50.9754



4,1 mm kæde. Varmt galv., svejst, RI a 30 m Ca. 29 x 15 mm

Steel chain hot dip, 4,1 mm, welded 30 m  
per PE bag.

54.KE5



Handiwash, 12 V med koldt-/varmtvands-  
beholder incl. vask

Handiwash, 12V with cold-/hot-water tank  
incl. wash basin

54.KE6



Handiwash, 24 V med koldt-/varmtvands-  
beholder incl. vask

Handiwash, 24 V with cold-/hot-water tank  
incl. wash basin

23.248X



Poleret aluminium indbygningstrin

Aluminium step, high-polished front

183 x 222 mm  
Dybde/Depth: 150  
mm

23.248



Poleret aluminium indbygningstrin

Polished aluminium recessed step

165 x 140 mm  
Dybde/Depth: 96  
mm

 Godt køb / best buy

## Kranplader

Vare nr.	Dimensioner	Belastning	Egenvægt
	mm		
54.G150830	400 x 400 x 30	8000	
54.G151040	400 x 400 x 40	10000	6
54.G151240	400 x 400 x 50	12000	
54.G151260	400 x 400 x 60	12000	9
54.G151540	500 x 500 x 40	15000	10
54.G151550	500 x 500 x 50	15000	12
54.G152060	500 x 500 x 60	20000	14
54.G152040	600 x 600 x 40	20000	14
54.G152350	600 x 600 x 50	23000	18
54.G152560	600 x 600 x 60	25000	21
54.G152540	800 x 800 x 40	25000	25
54.G153050	800 x 800 x 50	30000	31
54.G153560	800 x 800 x 60	35000	38
54.G154050	1000 x 1000 x 50	40000	48
54.G155060	1000 x 1000 x 60	50000	58
54.G156570	1000 x 1000 x 70	65000	68
54.G157080	1000 x 1000 x 80	70000	74
54.G158060	1200 x 1200 x 60	60000	
54.G158080	1200 x 1200 x 80	90000	113
54.G1530RO	Ø800 x 80	30000	30
54.G1535RO	Ø900 x 60	35000	
54.G1535RO1	Ø1000 x 50	35000	38
54.G1540RO	Ø1000 x 60	40000	45
54.G1550RO	Ø1000 x 80	50000	61
54.G1550RO1	Ø1200 x 60	50000	
54.G1570RO	Ø1200 x 80	70000	88

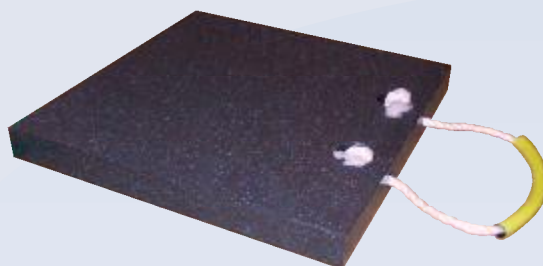

Rund  
Rund  
Rund  
Rund  
Rund  
Rund  
Rund

## Køreplader

Vare nr.	L	B	H	Vægt	Greb	Belastning
	mm	mm	mm	Kg		
54.PP200510	2000	500	10	10	2	30000
54.PP200515	2000	500	15	15	2	45000
54.PP200520	2000	500	20	20	2	75000
54.PP201010	2000	1000	10	20	4	30000
54.PP201015	2000	1000	15	30	4	45000
54.PP201020	2000	1000	20	40	4	75000
54.PP300510	3000	500	10	15	2	30000
54.PP300515	3000	500	15	22,5	2	45000
54.PP300520	3000	500	20	30	2	75000
54.PP301010	3000	1000	10	30	4	30000
54.PP301015	3000	1000	15	45	4	45000
54.PP301020	3000	1000	20	60	4	75000
54.PP400510	4000	500	10	20	2	30000
54.PP400515	4000	500	15	30	2	45000
54.PP400520	4000	500	20	40	2	75000
54.PP401010	4000	1000	10	40	4	30000
54.PP401015	4000	1000	15	60	4	45000
54.PP401020	4000	1000	20	80	4	75000

## Køreplader

Power plates





Vi producerer også OEM varer efter Deres ønske



Kontakt os for yderligere information.

# Spørg efter andre af vores specialkataloger.

Rodac Equipment



Rodac Pneumatic Tools

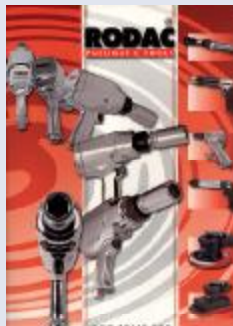

Bansbach Easylift System



Sindby Gummiprofiler



Sindby Ventilation



Kraftwerk Værktøj



Loctite Autokatalog

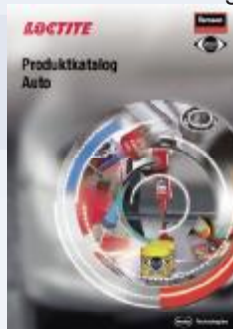

Karosseri



Kontakt os for yderligere information:

# [www.Sindby.dk](http://www.Sindby.dk)